

# Streetlight

## SERIES

"Street and area lighting applications for high visibility and safety."



ATHLON



NEOS



ANDROMEDA



KRONOS



KORNER



EQUINOX

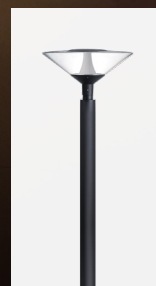

NeoPLACE



STICK



ATHLON is also available in wall mount version.

\* Pole is not included and has to be ordered separately.

**Available Color**

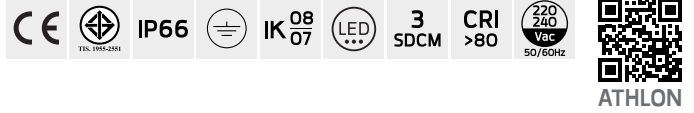

**Specification**

- Designed, Manufactured and tested according to IEC 60598.
- LM6 Die Cast Aluminium housing.
- Stainless steel screws.
- Nano Ceramic surface conversion.
- Double layer coating.
- Safety glass cover.
- Post-cured silicone gasket.
- High quality LED module and driver.
- GFR PA6.6 terminal block.
- Weather proof TPE grommet.
- Installation must be carried out according to the enclosed product manual.

**ATHLON**  
Area Light / Single Sided



**ATHLON**  
Area Light / Double Sided



<b>Luminaire Performance</b>	1840 – 6820 lm   28 – 58 W   65 – 117 lm/W							
<b>Beam Options</b>	Wide	Asymmetric	Bi-Symmetric	Road Optic	Elliptical H	T1	T3	T4
<b>Color Temperature</b>	2700K/ 3000K/ 4000K							
<b>Controller</b>	On-Off/ 1-10V/ DALI/ CASAMBI							

**Accessories**



1. NEOS Flood Light

\* Pole is not included and has to be ordered separately.

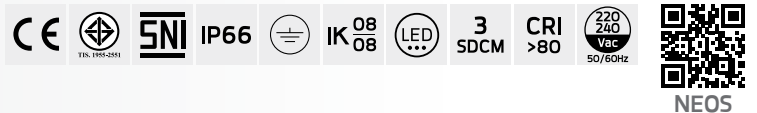

**Specification**

- Designed, Manufactured and tested according to IEC 60598.
- High-pressure Die Cast Aluminium body.
- Stainless steel screws.
- Nano Ceramic surface conversion.
- Double layer coating.
- Safety glass cover.
- Post-cured silicone gasket.
- High quality LED module and driver.
- Pre-wired cable from the factory.
- Installation must be carried out according to the enclosed product manual.

**Available Color**



**CUSTOMIZED SOLUTIONS** ■ NEOS [Flood Light Solutions]

**2. Pole Mount Adaptor, Ground Mount/ Wall Mount Configuration**

	OR		OR	
■ Pole mount adaptor - for square pole. - for pole dia 60 mm./ 76 mm./ 102-105 mm.		■ Ground mount / Wall mount adaptor		■ Turnable Round Base - for Ground mount/ Wall mount.
	+		OR	
■ Pole mount adaptor - Pole mount adaptor for square pole.		■ Corner Bracket		■ Pole mount adaptor - Pole mount adaptor for square pole.
	+			
		■ Wall Spacer		■ Wall Spacer

## NEOS Area Light / Single Sided

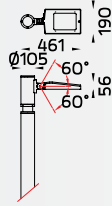

## NEOS Area Light / Double Sided

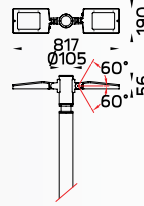

Luminaire Performance	3050 - 10300 lm   25 - 68 W   122 - 151 lm/W
Beam Options	
Color Temperature	3000K/ 4000K
Controller	On-Off/ 1-10V/ DALI/ CASAMBI

### Accessories



Aluminium pole



Steel pole



Anchor bolt



Glare Shield Cap



IP68 Connector



Photo Cell

\* Pole is not included and has to be ordered separately.

## CUSTOMIZED SOLUTIONS

### NEOS [Area Light Solutions]

**1. NEOS Area Light**  
(for Spigot Size : Ø76 mm.)

**2. Pole**

- Aluminium Pole.
- Steel Pole.

Wider spacing installation for cost effective solution



ANDROMEDA

### Specification

- Designed, Manufactured and tested according to IEC 60598.
- LM6 Die Cast Aluminium body.
- Stainless steel screws.
- Nano Ceramic surface conversion.
- Double layer coating.
- Safety glass cover.
- Post-cured silicone gasket.
- High quality LED module and driver.
- Pre-wired cable from the factory.
- Installation must be carried out according to the enclosed product manual.

## Mini ANDROMEDA Area Light / Single Sided

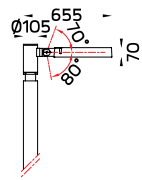

## Mini ANDROMEDA Area Light / Double Sided

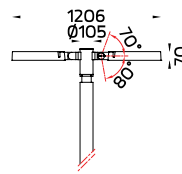

Luminaire Performance	5830 - 19140 lm   62 - 174 W   89 - 115 lm/W
Beam Options	
Color Temperature	3000K/ 4000K
Controller	On-Off/ 1-10V/ DALI

### Accessories



Aluminium pole



Steel pole



Anchor bolt

### Available Color



\* Pole is not included and has to be ordered separately.



Mini ANDROMEDA is also available in wall mount version.

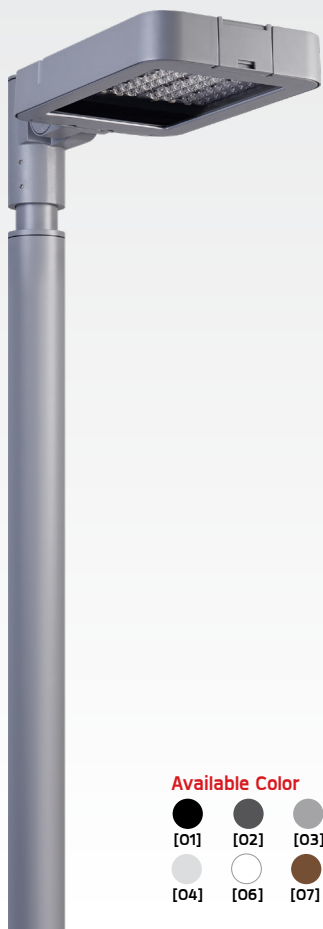

### Available Color



\* Pole is not included and has to be ordered separately.



KRONOS is also available in wall mount version.



### Specification

- Designed, Manufactured and tested according to IEC 60598.
- High-pressure Die Cast Aluminium body.
- Stainless steel screws.
- Nano Ceramic surface conversion.
- Double layer coating.
- Safety glass cover.
- Post-cured silicone gasket.
- High quality LED module and driver.
- Pre-wired cable from the factory.
- Installation must be carried out according to the enclosed product manual.

### KRONOS Area Light / Single Sided



### KRONOS Area Light / Double Sided

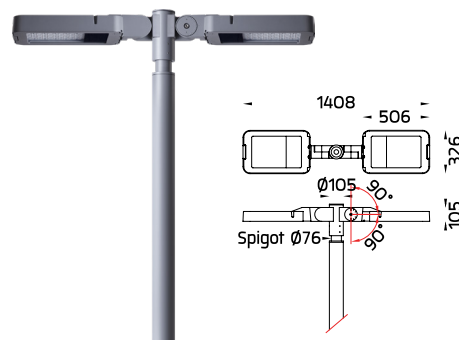

Luminaire Performance	11100 - 39100 lm   97 - 334 W   86 - 147 lm/W
Beam Options	
Color Temperature	3000K/ 4000K
Controller	On-Off/ 1-10V/ DALI

### Accessories



Steel pole



Anchor bolt



KORNER1



KORNER2



### Specification

- Designed, Manufactured and tested according to IEC 60598.
- LM6 Die Cast Aluminium and Extruded Aluminium body.
- Stainless steel screws.
- Nano Ceramic surface conversion.
- Double layer coating.
- Safety glass cover.
- Molded Lens from renowned manufacturer.
- Post-cured silicone gasket.
- High quality LED module and driver.
- GFR PA6.6 terminal block.
- Pre-wired cable from the factory.
- Installation must be carried out according to the enclosed product manual.

### Available Color



## CUSTOMIZED SOLUTIONS

### ■ KORNER [Pole Top Light Solutions]

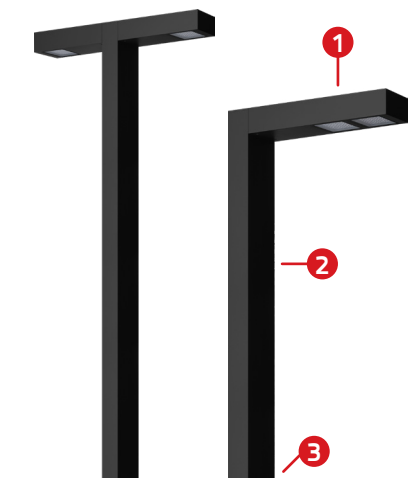

#### 1. KORNER

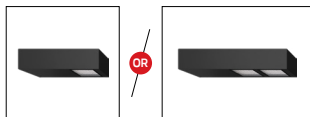

#### 2. Pole

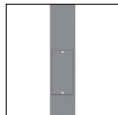

■ **Aluminium Pole**  
with Flange Base/ Internal Anchorage Unit  
Diameter : 150x82 mm.

■ **Steel Pole**  
with Flange Base/ Internal Anchorage Unit  
Diameter : 151x102 mm.

#### 3. Anchor Bolt Kit / Planted Root

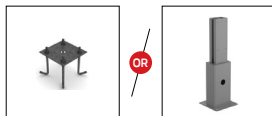

### ■ KORNER [Pole Clamp Solutions]

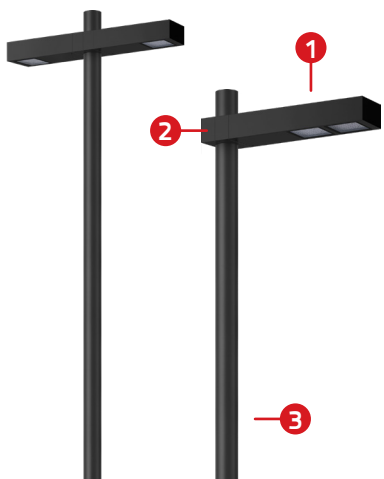

#### 1. KORNER

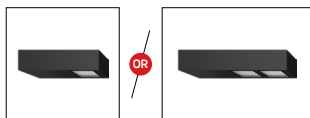

#### 2. Aluminium Pole Clamp



■ **For Single Sided**  
Diameter : 60/ 76 mm.

■ **For Double Sided**  
Diameter : 60/ 76 mm.

#### 3. Pole

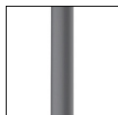

Diameter : 60/ 76 mm.

### ■ KORNER [Wall Mount Solutions]

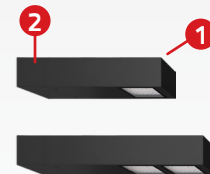

#### 1. KORNER



OR

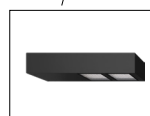

#### 2. Wall Adaptor



### KORNER1

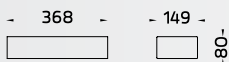

### KORNER2

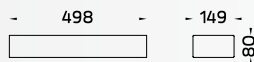

Luminaire Performance	2240 – 8340 lm   27 – 70 W   79 – 124 lm/W
Beam Options	T1 T2 T3 T4 T5 
Color Temperature	3000K/ 4000K
Controller	On-Off/ 1-10V/ DALI/ CASAMBI

#### Accessories



Aluminium pole



Steel pole



Anchor bolt



IP68 Connector



Distribution box



Pole clamp

\* Pole is not included and has to be ordered separately.



# EQUINOX



Neo EQUINOX is also available in wall mount version.

\* Pole is not included and has to be ordered separately.



### Specification

- Designed, Manufactured and tested according to IEC 60598.
- LM6 Die Cast Aluminium and Extruded Aluminium body.
- Stainless steel screws.
- Nano Ceramic surface conversion.
- Double layer coating.
- Safety glass cover.
- Post-cured silicone gasket.
- High quality LED module and driver.
- Molded Lens from renowned manufacturer.
- M20 cable gland/ weather proof TPE grommet.
- Installation work has to be carried out according to the enclosed product manual.

### Neo EQUINOX

Pole Top Light / Single Sided

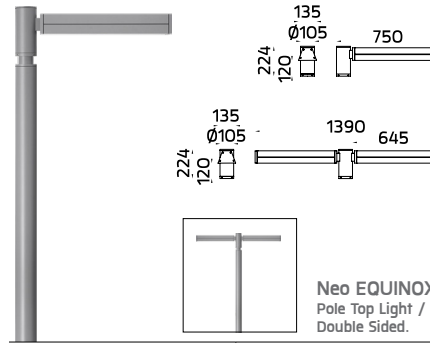

Neo EQUINOX Pole Top Light / Double Sided.

### Neo EQUINOX

Pole Clamp / Single Sided

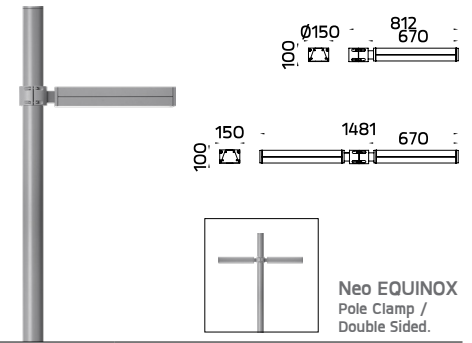

Neo EQUINOX Pole Clamp / Double Sided.

Luminaire Performance	2610 - 9880 lm   32 - 98 W   76 - 137 lm/W
Beam Options	
Color Temperature	2700/ 3000K/ 4000K
Controller	On-Off/ 1-10V/ DALI

### Accessories



### Available Color



# NeoPLACE



**NEW!**

NeoPLACE Direct Pole Top Light



### Specification

- Designed, Manufactured and Tested according to IEC 60598.
- LM6 Die Cast Aluminium and Spun Aluminium body.
- Stainless steel screws.
- Nano Ceramic surface conversion.
- Double layer coating.
- Polycarbonate protective cover.
- Post-cured silicone gasket.
- High quality LED module and driver.
- Pre-wired cable from the factory.
- Installation must be carried out according to the enclosed product manual.

### Available Color



## NeoPLACE Direct Pole Top Light



NeoPLACE  
Pole Top Light

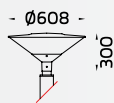

## NeoPLACE Direct Pole Top Light / Double Head



NeoPLACE  
Pole Top Light / Double Head

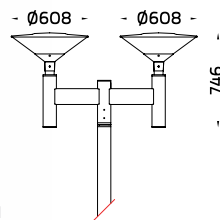

Luminaire Performance	1920 – 6440 lm   24 – 72 W   64 – 97 lm/W
Beam Options	
Color Temperature	2700K/ 3000K/ 4000K
Controller	On-Off/ 1-10V/ DALI/ CASAMBI

### Accessories



Uplight shield



Aluminium pole



Steel pole



Anchor bolt



NeoPLACE is also available in wall mount version.

\* Pole is not included and has to be ordered separately.



STICK

### Specification

- Designed, Manufactured and Tested according to IEC 60598.
- LM6 Die Cast Aluminium and Extruded Aluminium body.
- Stainless steel screws.
- Nano Ceramic surface conversion.
- Double layer coating.
- PC protective cover.
- Post-cured silicone gasket.
- High quality LED module and driver.
- Installation must be carried out according to the enclosed product manual.

## STICK Direct Light Column

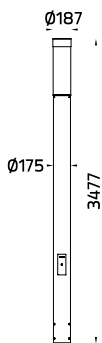

## STICK Direct Pole Top Light

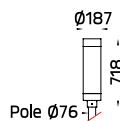

\* STICK Pole Top Light versions. Pole is not included and has to be ordered separately.

Luminaire Performance	3090 – 4770 lm   26 – 36 W   117 – 133 lm/W
Beam Options	
Color Temperature	3000K/ 4000K
Controller	On-Off/ 1-10V/ DALI/ CASAMBI

### Accessories



Aluminium pole



Steel pole



Anchor bolt

### Available Color



## NEW! STICK Direct



STICK Direct  
Light Column



STICK Direct  
Pole Top Light

■ Ideal Application



Unilamp Co., Ltd.

461 Ramintra Road, Kannayao, Bangkok 10230 Thailand

Tel : +66(0)2 943 2420-1, +66(0)2 946 4170-1

Fax : +66(0)2 943 2419

unilamp@unilamp.co.th | online@unilamp.co.th



www.unilamp.co.th