

RGBW

Lighting Control with DMX



Sipalay – Philippines



DMX Overview

Remote DMX Decoder

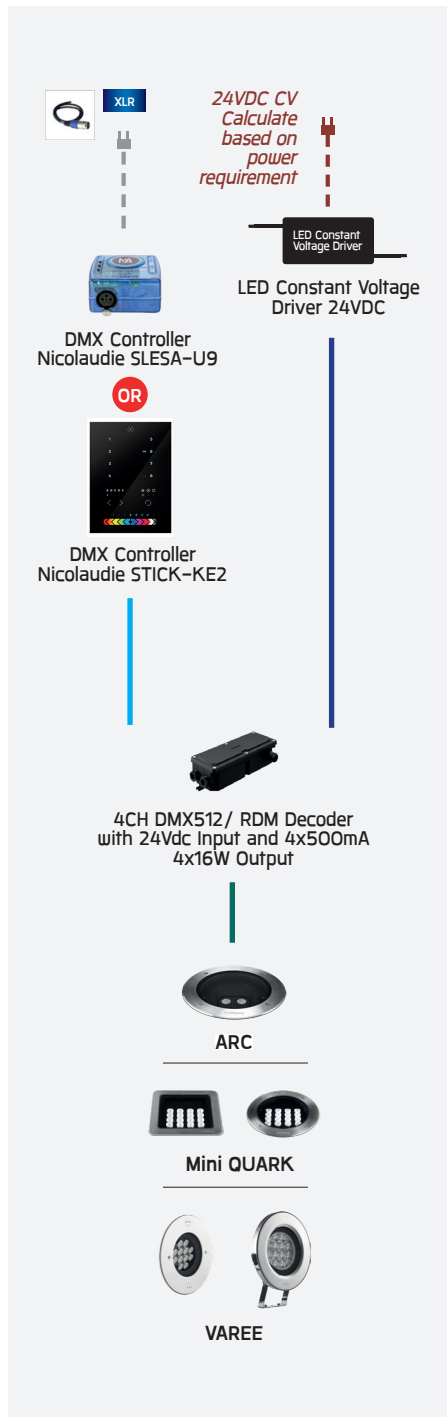

Integrated CV DMX Decoder

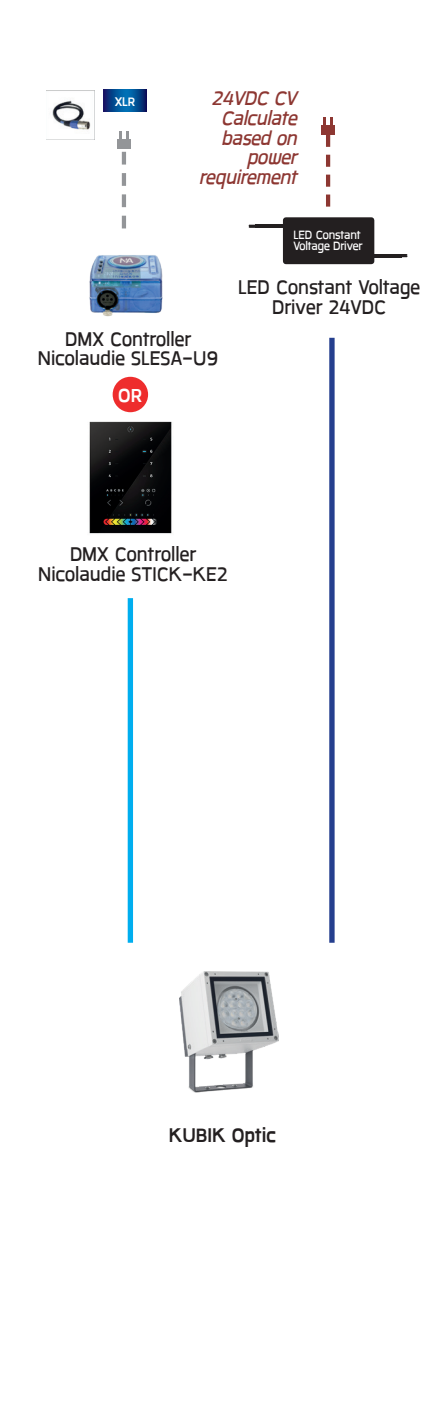

ID DMX

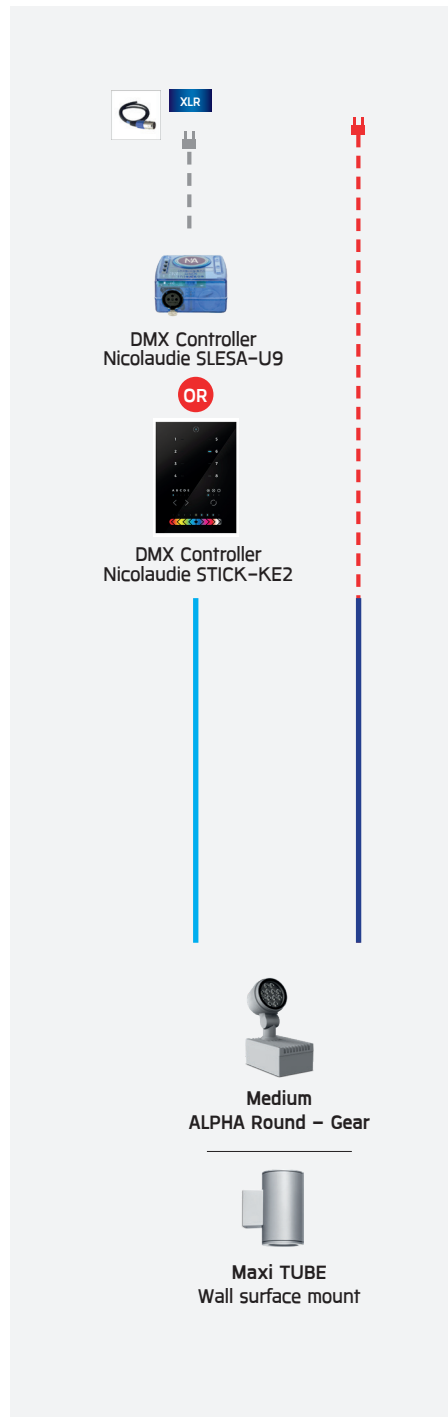

500mA or 700mA CC from DMX decoder

DMX Cable

Power 24 VDC for decoder

Power 220 VAC

Power 230 VAC for LED driver

Power 12 VDC for DMX controller

Power 220 - 240 VAC

Small scale DMX System

Up to 32 RGBW luminaires / Up to 300m distance

Applicable for RGBW luminaire with **Remote DMX Decoder**

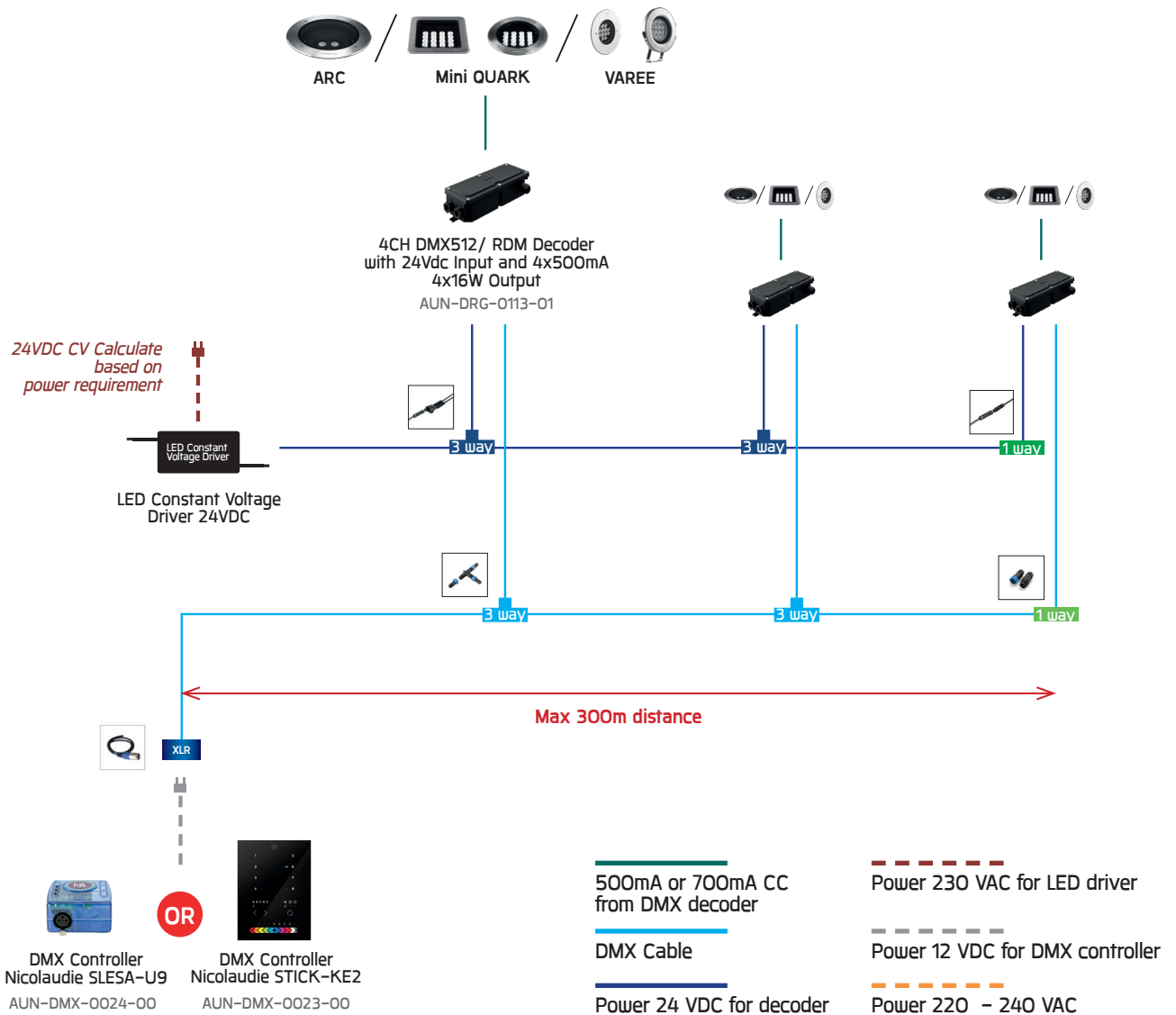

Accessories



DMX Controller Nicolaudie STICK-KE2
AUN-DMX-0023-00



DMX Controller Nicolaudie SLESA-U9
AUN-DMX-0024-00



DMX Controller Nicolaudie SLESA-U10
AUN-DMX-0025-00



Splitter DMX in IP67 Aluminium Box.
AUN-DMX-0027-01



LED Constant Voltage Driver 24VDC
72W.
AUN-DRG-0027-00



LED Constant Voltage Driver 24VDC
150W.
AUN-DRG-0011-00



LED Constant Voltage Driver 24VDC
200W.
AUN-DRG-0024-00



4CH DMX512/ RDM Decoder with
24Vdc Input and 4x500mA 4x16W
Output In IP67 GFR Polymer Box.
AUN-DRG-0113-01



IP67 Water Tight Connecting Device, 3
Pole, Cable Diameter 4.5 - 11mm. [DMX]
AUN-CON-0022-00



IP67 Water Tight Connecting Device with
Distribution block, 3 pole,
1 input, 2 outputs, Cable Diameter
4.5 - 11mm. [DMX]
AUN-CON-0023-00



IP68 Water Tight Connecting Device, 3
Pole, Cable Diameter 5.0 - 9.5mm.
AUN-CON-0009-00



IP68 Water Tight Connecting Device with
Distribution block, 3 pole,
1 input, 2 outputs, Cable Diameter
5.0 - 9.5mm.
AUN-CON-0010-00

Medium scale DMX System

Up to 256 RGBW luminaires / Up to 300m distance

Applicable for RGBW luminaire with Remote DMX Decoder

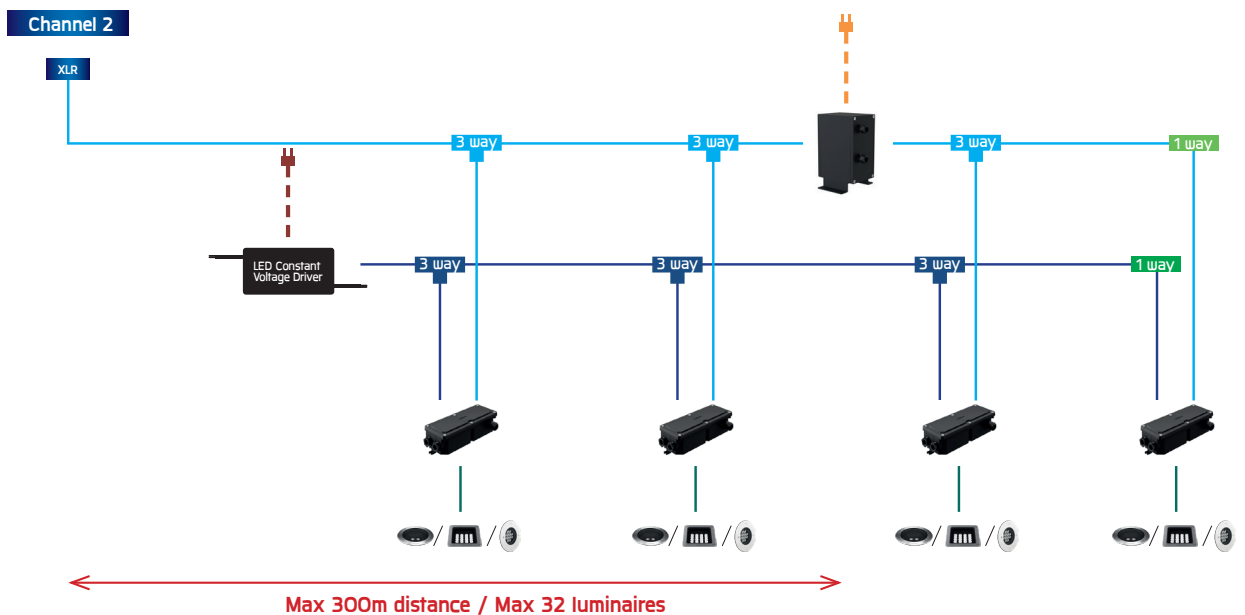
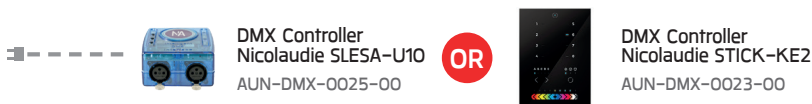
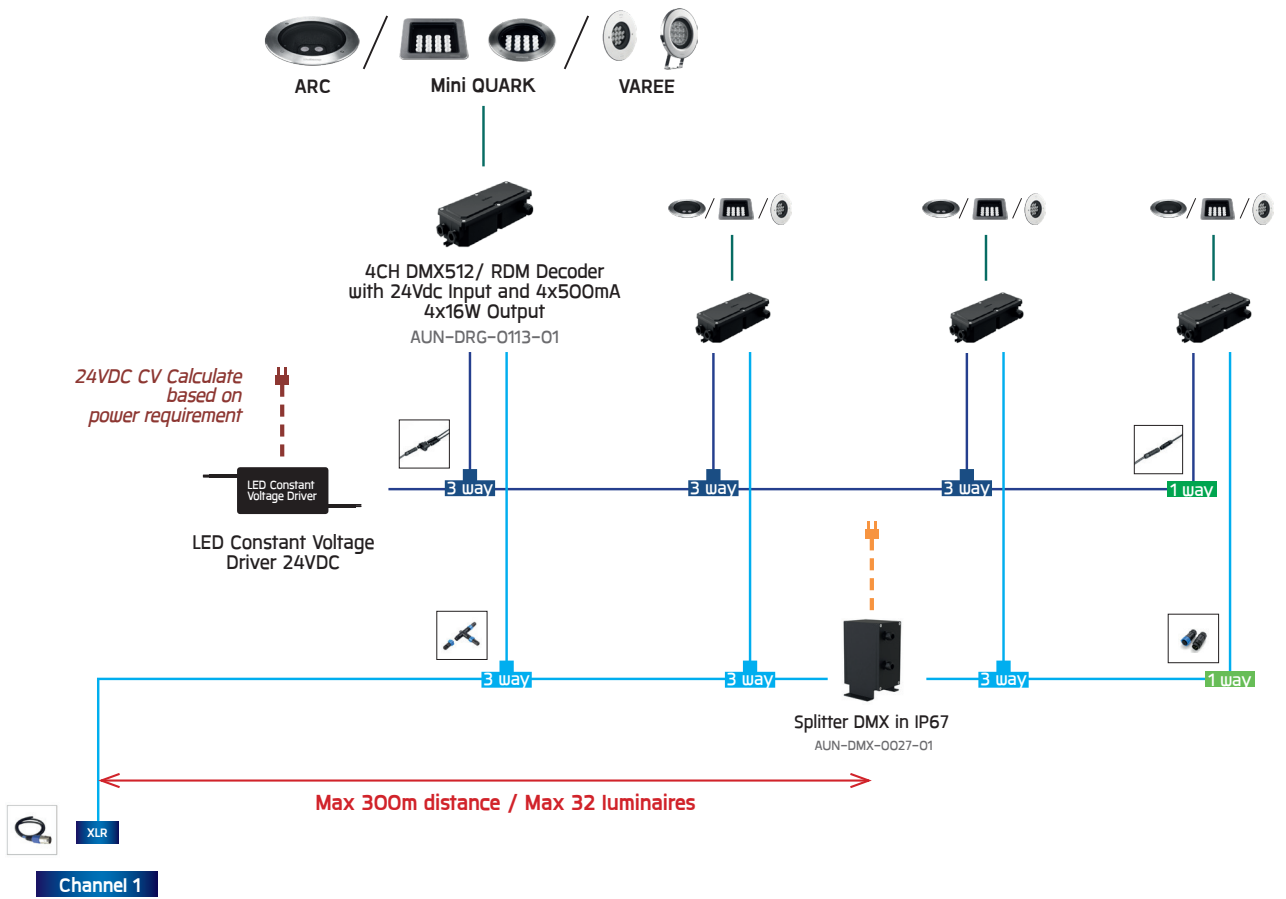

Small scale DMX System

Up to 32 RGBW luminaires / Up to 300m distance

Applicable for RGBW luminaire with **Integrated CV DMX Decoder**

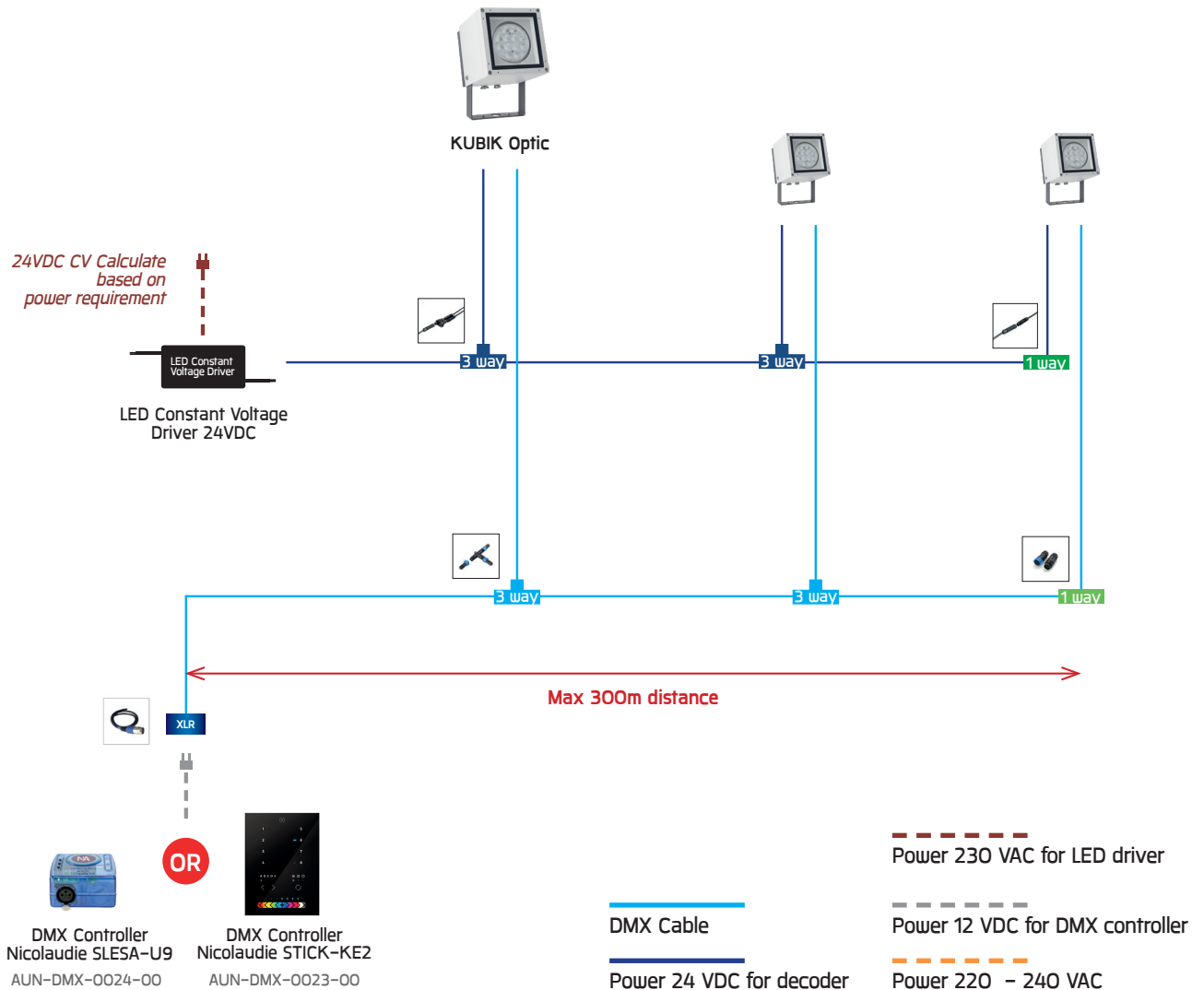

Accessories



DMX Controller Nicolaudie STICK-KE2
AUN-DMX-0023-00



DMX Controller Nicolaudie SLESA-U9
AUN-DMX-0024-00



DMX Controller Nicolaudie SLESA-U10
AUN-DMX-0025-00



Splitter DMX in IP67 Aluminium Box.
AUN-DMX-0027-01



LED Constant Voltage Driver 24VDC
72W.
AUN-DRG-0027-00



LED Constant Voltage Driver 24VDC
150W.
AUN-DRG-0011-00



LED Constant Voltage Driver 24VDC
200W.
AUN-DRG-0024-00



IP67 Water Tight Connecting Device, 3
Pole, Cable Diameter 4.5 - 11mm. [DMX]
AUN-CON-0022-00



IP67 Water Tight Connecting Device with
Distribution block, 3 pole,
1 input, 2 outputs, Cable Diameter
4.5 - 11mm. [DMX]
AUN-CON-0023-00



IP68 Water Tight Connecting Device, 3
Pole, Cable Diameter 5.0 - 9.5mm.
AUN-CON-0009-00



IP68 Water Tight Connecting Device with
Distribution block, 3 pole,
1 input, 2 outputs, Cable Diameter
5.0 - 9.5mm.
AUN-CON-0010-00

Medium scale DMX System

Up to 256 RGBW luminaires / Up to 300m distance

Applicable for RGBW luminaire with **Integrated CV DMX Decoder**

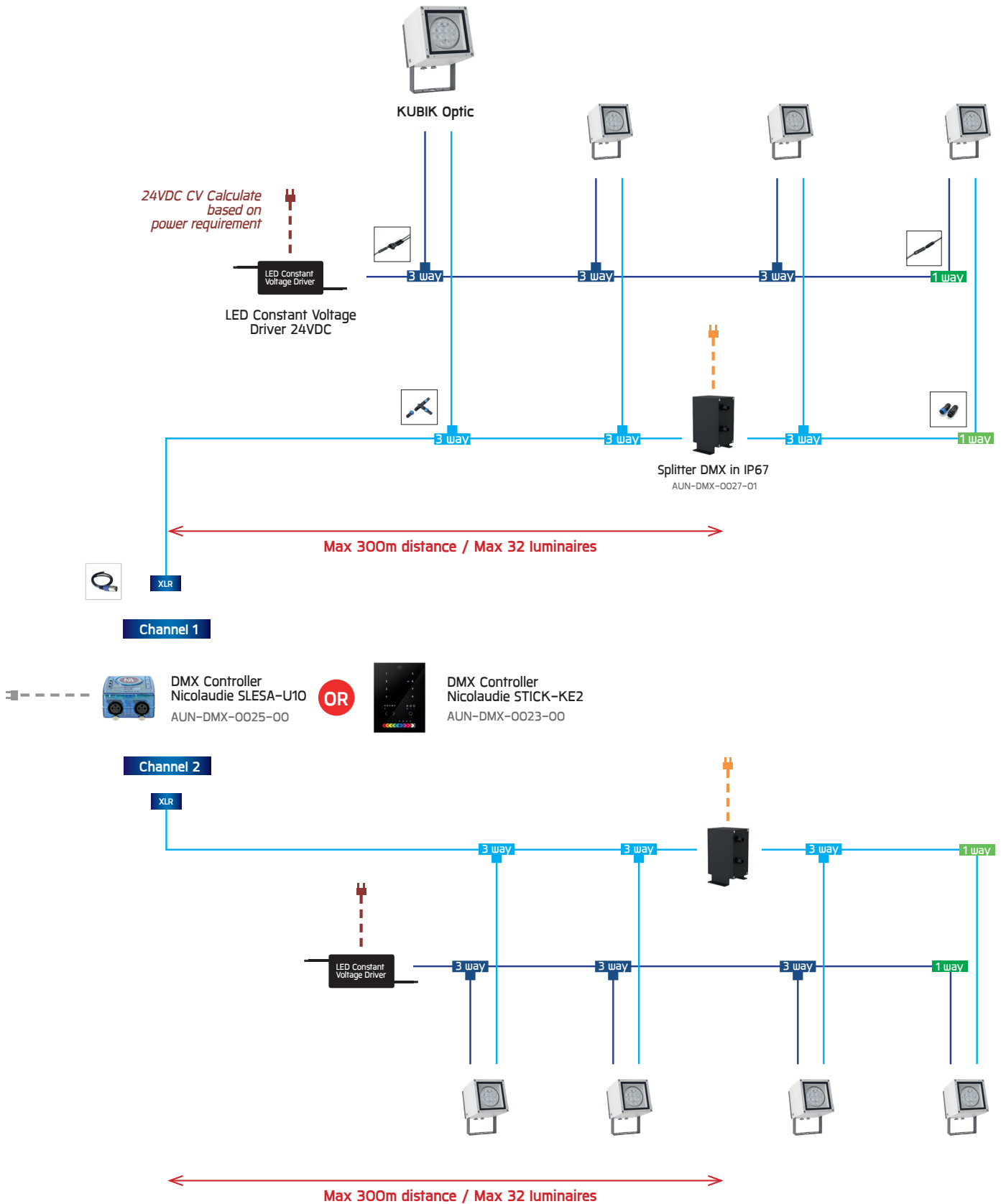

Small scale DMX System

Up to 32 RGBW luminaires / Up to 300m distance

Applicable for RGBW luminaire with **ID DMX**

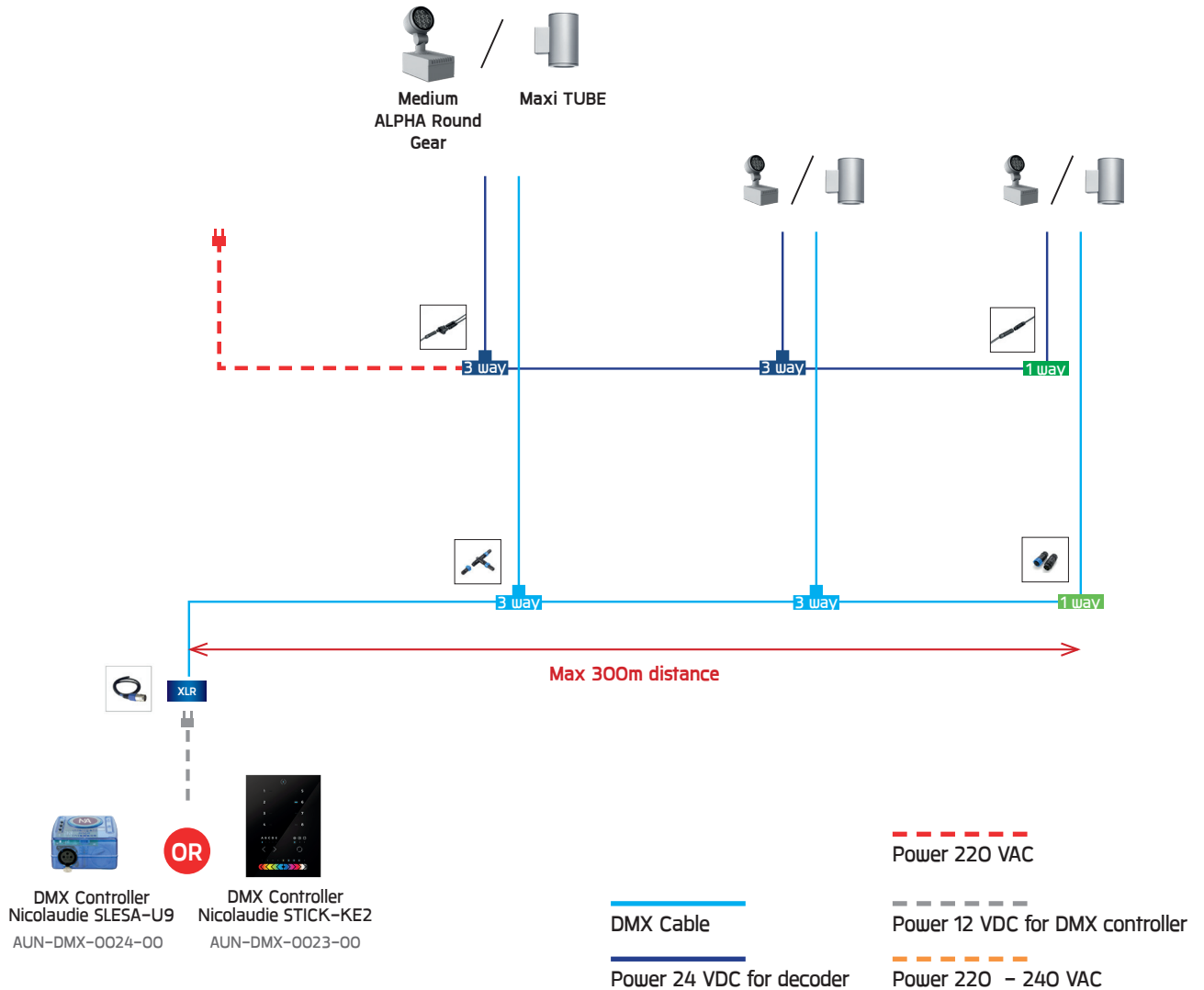

Accessories



DMX Controller Nicolaudie STICK-KE2
AUN-DMX-0023-00



DMX Controller Nicolaudie SLESA-U9
AUN-DMX-0024-00



DMX Controller Nicolaudie SLESA-U10
AUN-DMX-0025-00



Splitter DMX in IP67 Aluminium Box.
AUN-DMX-0027-01



IP67 Water Tight Connecting Device, 3 Pole, Cable Diameter 4.5 - 11mm. [DMX]
AUN-CON-0022-00



IP67 Water Tight Connecting Device with Distribution block, 3 pole, 1 input, 2 outputs, Cable Diameter 4.5 - 11mm. [DMX]
AUN-CON-0023-00



IP68 Water Tight Connecting Device, 3 Pole, Cable Diameter 5.0 - 9.5mm.
AUN-CON-0009-00



IP68 Water Tight Connecting Device with Distribution block, 3 pole, 1 input, 2 outputs, Cable Diameter 5.0 - 9.5mm.
AUN-CON-0010-00

Medium scale DMX System

Up to 256 RGBW luminaires / Up to 300m distance

Applicable for RGBW luminaire with ID DMX

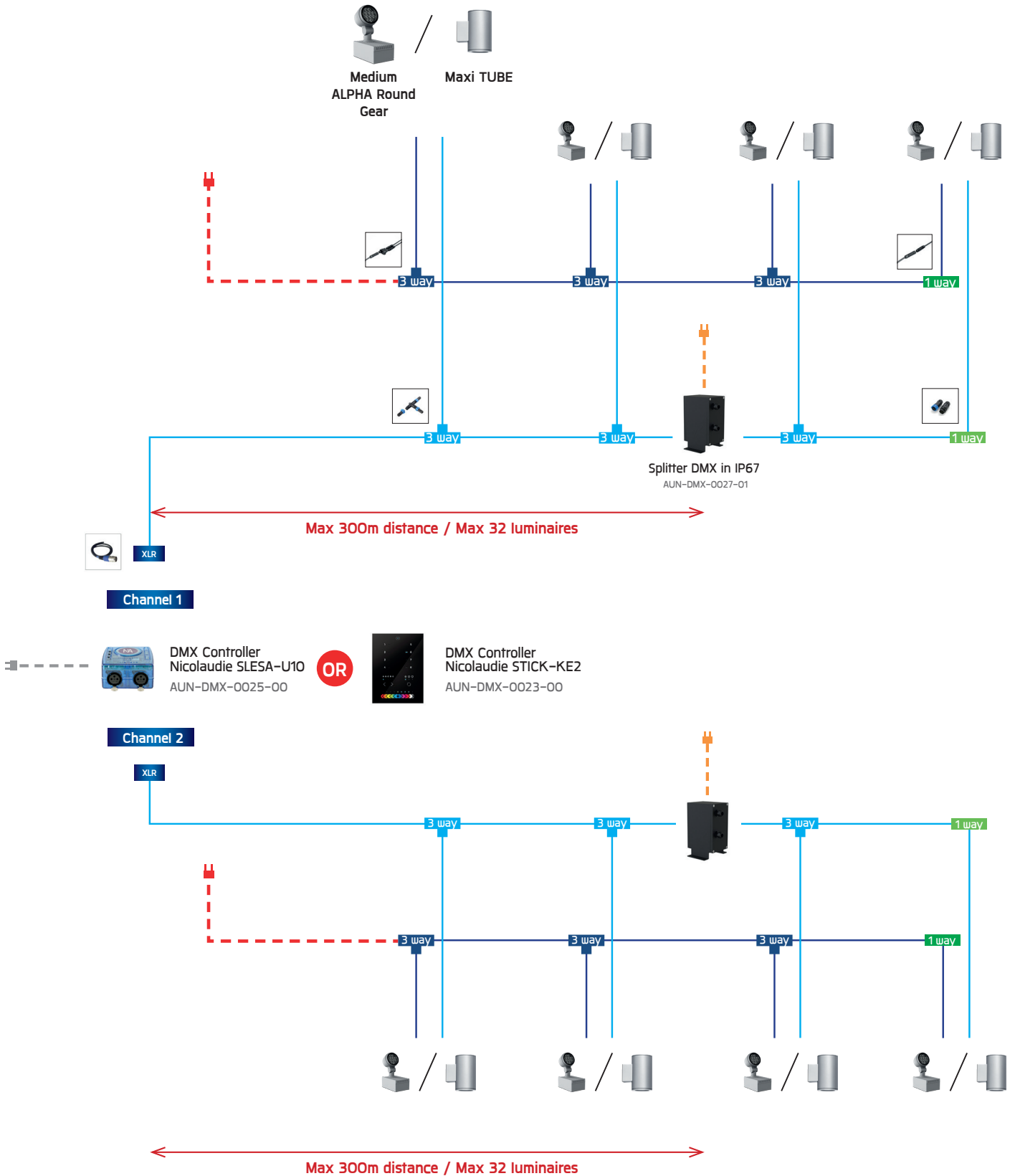

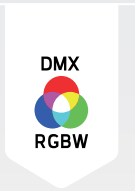

ARC [DMX]
Inground uplighter

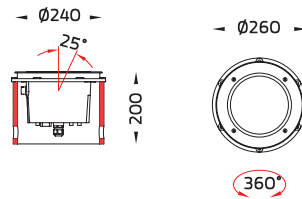

Specification

- High-pressure Die Cast Aluminium alloy body and components.
- Front cover in 316 stainless steel brush finished.
- Recessed housing made of GFR polymer.
- Luminaire withstands a maximum static load of 1000 kg.
- Nano Ceramic surface conversion, resistant to corrosive environment. UniShield-16
- Impact resistant safety tempered glass cover. Able to withstand the temperature up to 250°C.
- Glass flushes to the front cover, no accumulation of dust and water.
- Molded PC lens from renowned manufacturers in various light distribution patterns.
- Post-cured treated silicone gasket.
- External screws are in stainless steel with protection grease.
- Cable entry protected by M20 cable gland.
- High efficiency LED module utilized chips from world renowned manufacturer.
- Driver is not included and has to be ordered separately.
- The water drainage system must be tested to ensure that it is working sufficiency and efficiency.

Luminaire Performance	610 – 680 lm 22 W 27 – 30 lm/W
Beam Options	
Color Temperature	RGBW
Controller	Remote DMX Decoder

Accessories

Honey comb louver	CV Driver	DMX Decoder
Splitter DMX	Cable	XLR 3 pin
IP67 Water Tight	IP68 Water Tight	STICK KE2
SLESA		

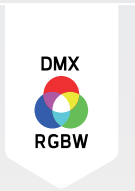

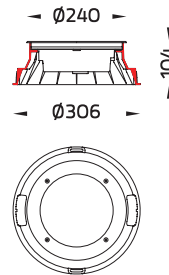
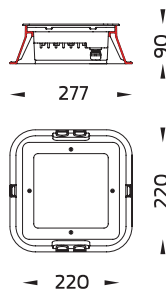

QUARK

Mini QUARK [DMX]
Inground uplighter













Specification

- High-pressure Die Cast Aluminium alloy body and components.
- Front cover in 316 stainless steel brush finished.
- Recessed housing made of GFR polymer.
- Luminaire withstands a maximum static load of 1000 kg.
- Nano Ceramic surface conversion, resistant to corrosive environment. UniShield-16
- Impact resistant safety tempered glass cover. Able to withstand the temperature up to 250°C.
- Glass flushes to the front cover, no accumulation of dust and water.
- Molded PC lens from renowned manufacturers in various light distribution patterns.
- Post-cured treated silicone gasket.
- External screws are in stainless steel with protection grease.
- Cable entry protected by M20 cable gland.
- High efficiency LED module utilized chips from world renowned manufacturer.
- Driver is not included and has to be ordered separately.
- The water drainage system must be tested to ensure that it is working sufficiency and efficiency.

Luminaire Performance	1440 – 2070 lm 22 – 32 W 57 – 73 lm/W
Beam Options	  
Color Temperature	RGBW
Controller	Remote DMX Decoder

Accessories

 Honey comb louver	 Softening filter	 CV Driver
 DMX Decoder	 Splitter DMX	 Cable
 IP67 Water Tight	 IP68 Water Tight	 XLR 3 pin
 STICK KE2	 SLESA	



VAREE
Wall Recess

VAREE
Spotlight

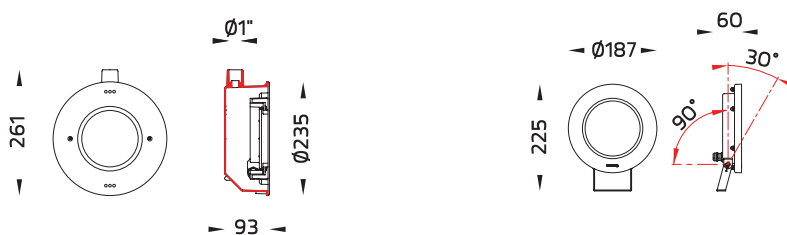

Specification

- Supreme corrosion proof Under Water grade Stainless Steel.
- Injected GFR Engineering Polymer body component.
- Wall recessed housing made of GFR polymer.
- Impact resistant safety tempered glass cover.
- Molded PC lens from renowned manufacturers in various light distribution patterns.
- Post-cured treated silicone gasket.
- Marine grade 316 stainless steel screw.
- Cable entry protected by M16 cable gland.
- High efficiency LED module utilized chips from world renowned manufacturer.
- Driver is not included and has to be ordered separately.
- Pre-wired with 5x1.0 sqmm. PP + TPE cable. VDE approved.
- Installation work has to be carried on according to the enclosed installation manual.
- To avoid over-heating, this luminaire has to use under water only.

Luminaire Performance	1250 – 1560 lm 24 W 52 – 65 lm/W								
Beam Options	<table border="0"> <tr> <td>Medium</td> <td>Wide</td> <td>Asymmetric</td> <td>44°/10°</td> </tr> <tr> <td></td> <td></td> <td></td> <td></td> </tr> </table>	Medium	Wide	Asymmetric	44°/10°				
Medium	Wide	Asymmetric	44°/10°						
Color Temperature	RGBW								
Controller	Remote DMX Decoder								

Accessories		
	Honey comb louver	
	DMX Decoder	
	IP67 Water Tight	
	IP68 Water Tight	
	STICK KE2	



KUBIK Optic – Ground Mount (DMX)
Spotlight



KUBIK

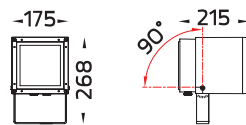

Specification

- High-pressure Die Cast Aluminium alloy body and components.
- Nano Ceramic surface conversion, resistant to corrosive environment. UniShield-16
- Impact resistant safety tempered glass cover.
- Glass flushes to the front cover, no accumulation of dust and water.
- Molded PC lens from renowned manufacturers in various light distribution patterns.
- Adjustable aiming unit through graduated scale.
- Post-cured treated silicone gasket.
- External screws are in stainless steel with protection grease.
- Cable entry protected by M20 cable gland.
- High efficiency LED module utilized chips from world renowned manufacturer.
- Driver is not included and has to be ordered separately.
- Pre-wired cable from factory.
- Pre-wired with 2x1.0 sqmm. HO7RN-F neoprene cable. IMQ approved.
- Pre-wired with shielded DMX cable.
- Installation work has to be carried on according to the enclosed installation manual.
- Available with remote driver.

Luminaire Performance	1420 – 1510 lm 24 W 59 – 62 lm/W								
Beam Options	<table border="0"> <tr> <td>Medium</td> <td>Wide</td> <td>45°/14°</td> <td>14°/45°</td> </tr> <tr> <td></td> <td></td> <td></td> <td></td> </tr> </table>	Medium	Wide	45°/14°	14°/45°				
Medium	Wide	45°/14°	14°/45°						
Color Temperature	RGBW								
Controller	Integrated DMX Decoder								

Available Color

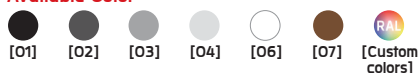

Accessories

Honey comb louver	Softening filter	CV Driver
Glare Shield	Splitter	Tree strap
Pole clamp	Cable	Splitter DMX
IP67 Water Tight	IP68 Water Tight	XLR 3 pin
STICK KE2	SLESA	

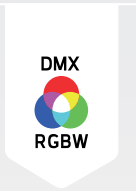

ALPHA

Medium ALPHA Round – Gear [DMX]
Spotlight

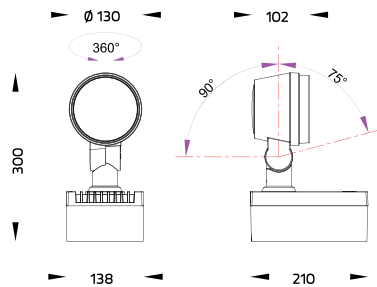

Features

- Designed, Manufactured and tested according to IEC 60598.
- LM6 Die Cast Aluminium body.
- Stainless steel screws.
- Nano Ceramic surface conversion.
- Double layer coating.
- Safety glass cover.
- Post-cured silicone gasket.
- High quality LED module.
- Weather proof TPE grommet.
- Installation must be carried out according to the enclosed product manual.
- High CC quality DMX driver
- Equipped with 10kV surge protection device.
- Pre-wired with shielded DMX cable.

Available Color



Luminaire Performance	1440 – 1630 lm 27 W 53 – 60 lm/W								
Beam Options	<table border="1"> <tr> <td>Medium</td> <td>Wide</td> <td>46°/16°</td> <td>16°/46°</td> </tr> <tr> <td></td> <td></td> <td></td> <td></td> </tr> </table>	Medium	Wide	46°/16°	16°/46°				
Medium	Wide	46°/16°	16°/46°						
Color Temperature	RGBW								
Controller	ID and Integrated DMX Decoder								

Accessories

	Aluminium pole		Steel pole		Glare Shield Cap
	Honey comb louver		Softening filter		Earth spike
	Tree strap		Pole clamp		Mounting Arm

*Please see Poles & Anchor bolt section for pole mounting options

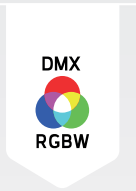
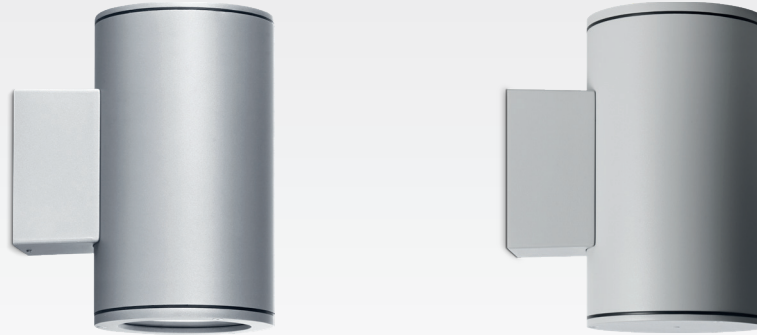

TUBE

Maxi TUBE Wall surface mount

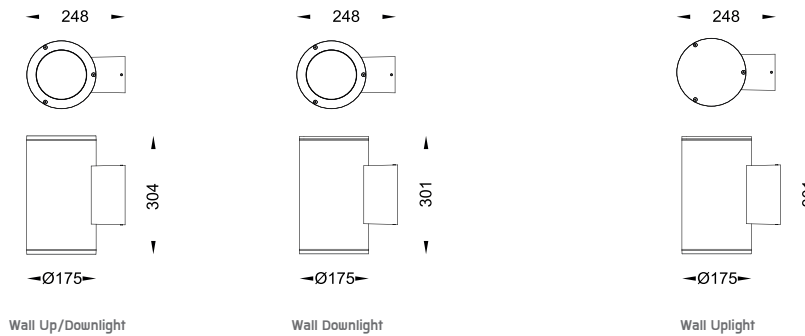

Features

- Designed, Manufactured and tested according to IEC 60598.
- LM6 Die Cast Aluminium and Extruded Aluminium body.
- Stainless steel screws.
- Nano Ceramic surface conversion.
- Double layer coating.
- Safety glass cover.
- Post-cured silicone gasket.
- High quality LED module and driver.
- Weather proof TPE grommet.
- Installation must be carried out according to the enclosed product manual.

Luminaire Performance	880 – 1900 lm 27 – 46 W 32 – 41 lm/W
Beam Options	
Color Temperature	RGBW
Controller	ID and Integrated DMX Decoder



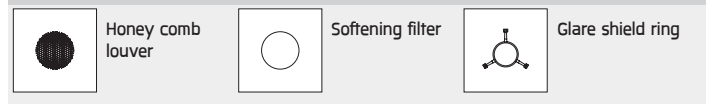













Accessories



Available Color





Ordering Code	Product Name	
LED Constant Voltage Driver		
	AUN-DRG-0027-00	LED Constant Voltage Driver 24Vdc 72W. for ARC, KUBIK, QUARK, VAREE
	AUN-DRG-0011-00	LED Constant Voltage Driver 24Vdc 150W. for ARC, KUBIK, QUARK, VAREE
	AUN-DRG-0024-00	LED Constant Voltage Driver 24Vdc 200W. for ARC, KUBIK, QUARK, VAREE
	AUN-DRG-0113-01	4CH DMX512/ RDM Decoder with 24Vdc Input and 4x500mA 4x16W Output In IP67 GFR Polymer Box. for ARC, KUBIK, QUARK, VAREE
DMX Controller		
	AUN-DMX-0023-00	DMX Controller Nicolaudie STICK-KE2 for ARC, KUBIK, QUARK, VAREE
	AUN-DMX-0024-00	DMX Controller Nicolaudie SLESA-U9 for ARC, KUBIK, QUARK, VAREE
	AUN-DMX-0025-00	DMX Controller Nicolaudie SLESA-U10 for ARC, KUBIK, QUARK, VAREE
	AUN-DMX-0026-00	XLR 3 Pin Male Connector with UNITRONIC Li2YCYv (TP) cable length 1000mm. [DMX] for ARC, KUBIK, QUARK, VAREE
	AUN-DMX-0027-00	Splitter DMX in IP67 Aluminium Box. for ARC, KUBIK, QUARK, VAREE
Connector and Distribution Box		
	AUN-CON-0022-00	IP67 Water Tight Connecting Device, 3 Pole, Cable Diameter 4.5 - 11mm. [DMX] for ARC, KUBIK, QUARK, VAREE
	AUN-CON-0023-00	IP67 Water Tight Connecting Device with Distribution block, 3 pole, 1 input, 2 outputs, Cable Diameter 4.5 - 11mm. [DMX] for ARC, KUBIK, QUARK, VAREE
	AUN-CON-0009-00	IP68 Water Tight Connecting Device, 3 Pole, Cable Diameter 5.0 - 9.5mm. for ARC, KUBIK, QUARK, VAREE
	AUN-CON-0010-00	IP68 Water Tight Connecting Device with Distribution block, 3 pole, 1 input, 2 outputs, Cable Diameter 5.0 - 9.5mm. for ARC, KUBIK, QUARK, VAREE
Cable		
	ATR-CAB-0006-00	Cable UNITRONIC Li2YCYv (TP) length 2000mm. [DMX] for ARC, KUBIK, QUARK, VAREE
	AUN-CAB-0040-00	Cable HO7RN-F 2x1sqmm length 2000mm. for ARC, KUBIK, QUARK, VAREE
	AUN-CAB-0039-00	Cable HO7RN-F 3x1sqmm length 2000mm. for ARC, KUBIK, QUARK, VAREE

DMX control option RGBW

✦ **Ideal** Application



Unilamp Co., Ltd.

461 Ramintra Road, Kannayao, Bangkok 10230 Thailand

Tel : +66[0]2 943 2420-1, +66[0]2 946 4170-1

Fax : +66[0]2 943 2419

unilamp@unilamp.co.th | online@unilamp.co.th



www.unilamp.co.th