



NEW!

■ Medium CAP

CAP

‘A fresh range of *bollards*
and low mounted *pole lights*.’



NEW!

■ Medium CAP



■ Mini CAP
Bollard



■ Mini CAP
Short Bollard

■ BOLLARDS

CAP

NEW
Added

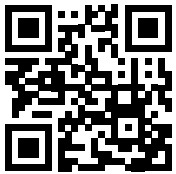

www.unilamp.co.th/en/p/cap

The **CAP** Family is a fresh range of bollards and low mounted pole lights. Designed from scratch with the latest lighting requirements in mind. The highly efficient LEDs are shielded and emit no upward light. The light engine features great color consistency, excellent color rendering index and dimming options. Specification grade optics make the medium sized version a highly competitive lighting tool for demanding professional lighting tasks. With its compact dimensions the small sized **CAP** is a smart solution for residential lighting projects. Regardless of size the prewired supply cable, numerous mounting solutions and minimized amount of screws assure a simplified installation process.

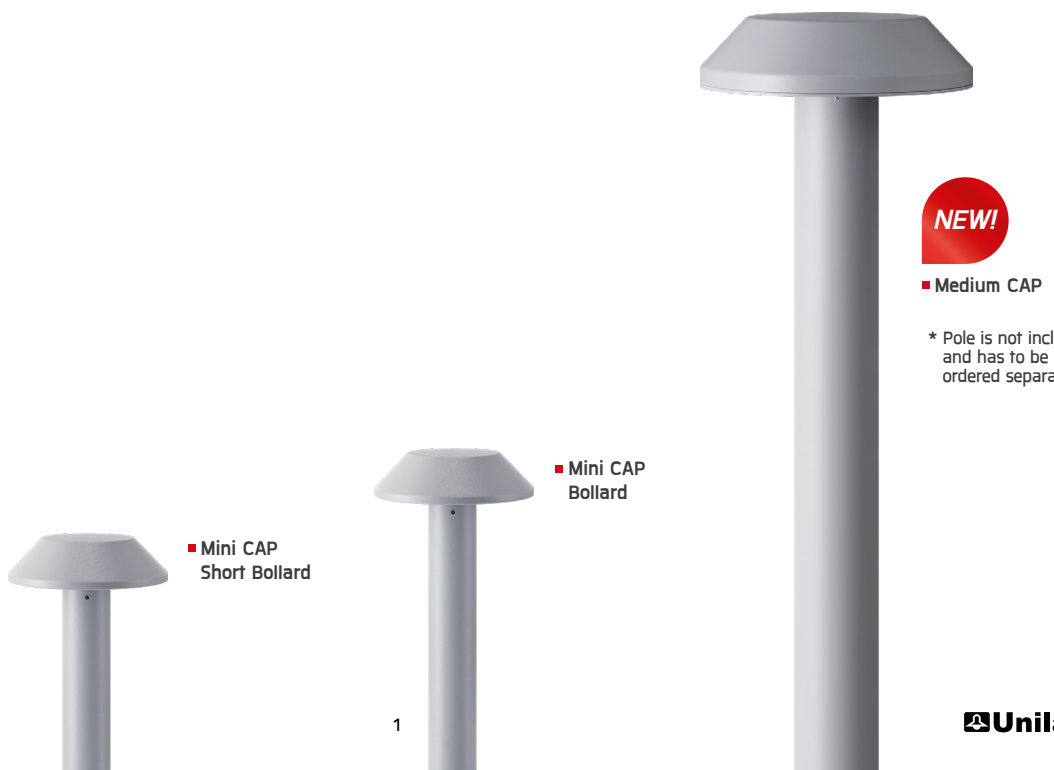

NEW!

■ Medium CAP

* Pole is not included and has to be ordered separately.

■ Mini CAP Short Bollard

■ Mini CAP Bollard



Specification

- Designed, Manufactured and tested according to IEC 60598
- LM6 Die Cast Aluminium and Extruded Aluminium body.
- Stainless steel screws.
- Nano Ceramic surface conversion.
- Double layer coating.
- Safety glass cover.
- Post-cured silicone gasket.
- High quality LED module and driver.
- Bollard pre-wired with outdoor cable.
- Installation must be carried out according to the enclosed product manual.

Available Color

Black	[replace the last 2 digits of ordering code with O1]
Graphite	[replace the last 2 digits of ordering code with O2]
Dark Grey	[replace the last 2 digits of ordering code with O3]
Aluminium Silver	[replace the last 2 digits of ordering code with O4]
White	[replace the last 2 digits of ordering code with O6]
Wooden Brown	[replace the last 2 digits of ordering code with O7]



■ Medium CAP

* Pole is not included and has to be ordered separately.

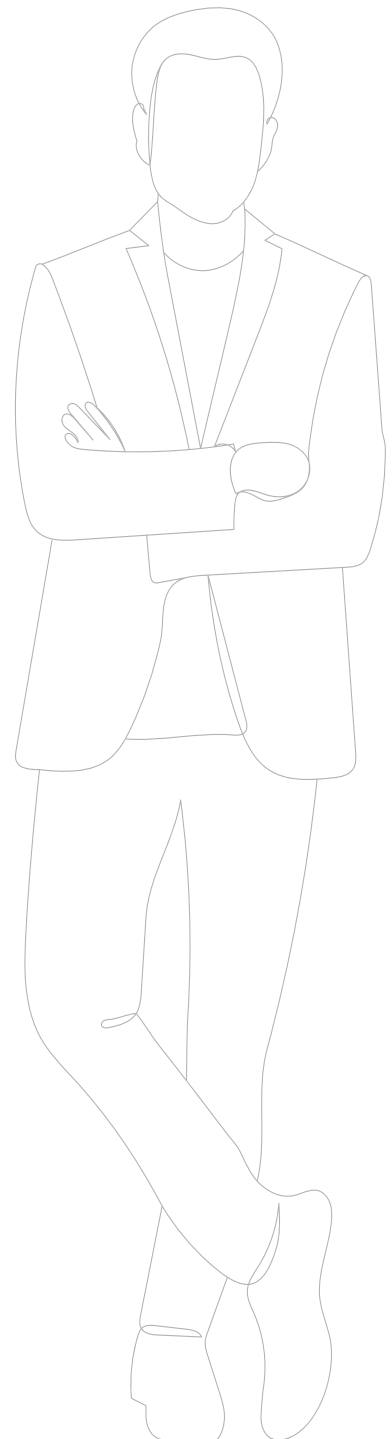

■ Medium CAP 90

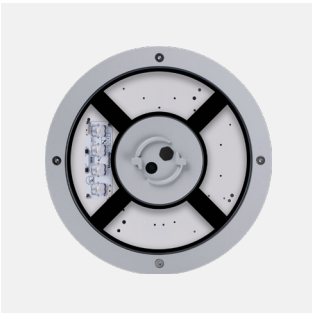

■ Medium CAP 180

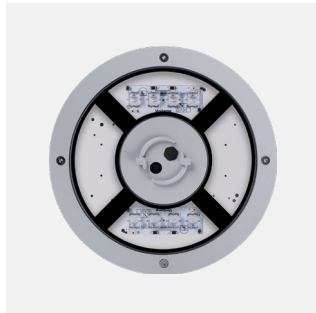

■ Medium CAP 360

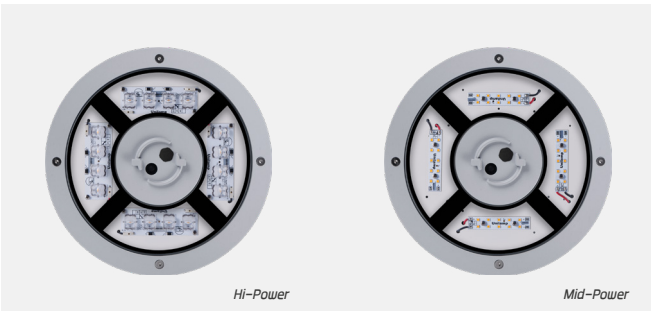

Hi-Power

Mid-Power

Mini CAP – Short Bollard
Flange Base /
Flange Base CVDA

Mini CAP – Short Bollard
Root Mount Base /
Root Mount Base CVDA

Mini CAP – Bollard
Flange Base /
Flange Base CVDA

Mini CAP – Bollard
Root Mount Base /
Root Mount Base CVDA

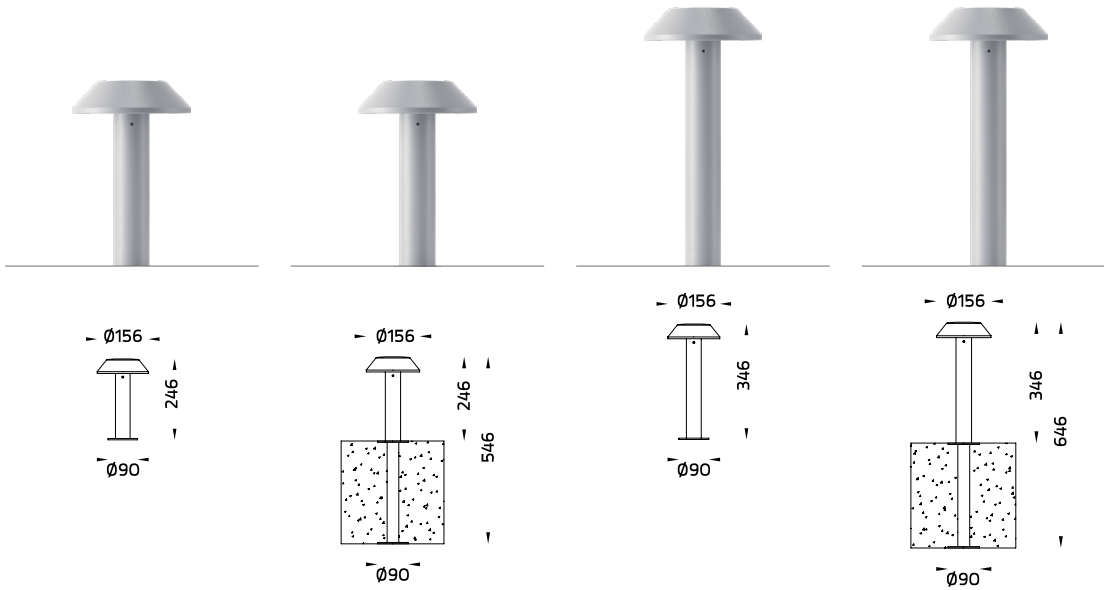

Mini CAP

BOLLARDS

- Mini CAP – Short Bollard Flange Base / Flange Base CVDA / 7178
- Mini CAP – Short Bollard Root Mount Base / Root Mount Base CVDA / 7878
- Mini CAP – Bollard Flange Base / Flange Base CVDA / 7177
- Mini CAP – Bollard Root Mount Base / Root Mount Base CVDA / 7877

LED Module	640 – 1010 lm 7 – 9W 91 – 112 lm/W
Beam Options	
Color Temperature	2700K / 3000K / 4000K
Controller	On-Off 24V Remote driver On-Off / DALI [CVDA]

Accessories

Pre-wired cable

CV Driver

Medium CAP 90 – Head /
 Medium CAP 180 – Head /
 Medium CAP 360 – Head

NEW!



* Pole is not included and has to be ordered separately.

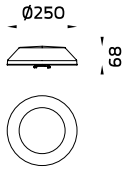

Mini CAP Bollard simulation



Medium CAP simulation

Medium CAP

NEW!

BOLLARDS

Medium CAP 90 – Head / 7879
 Medium CAP 180 – Head / 7880
 Medium CAP 360 – Head / 7881

LED Module

710 – 3600 lm
 11 – 32W
 60 – 117 lm/W

Beam Options

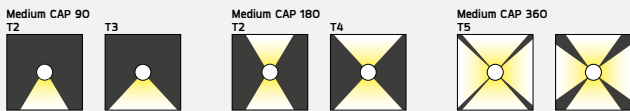

Color Temperature

2700K / 3000K / 4000K

Controller

On-Off / 1-10V / DALI / CASAMBI

Accessories



IP68 Connector



Anchor Bolt



Aluminium pole

• MODULAR SOLUTIONS

Medium CAP

Bollard Version



* Pole is not included and has to be ordered separately.

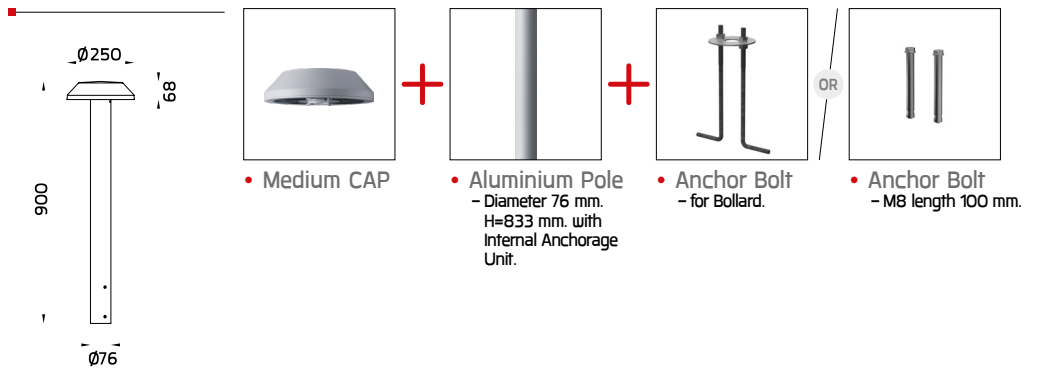

Medium CAP





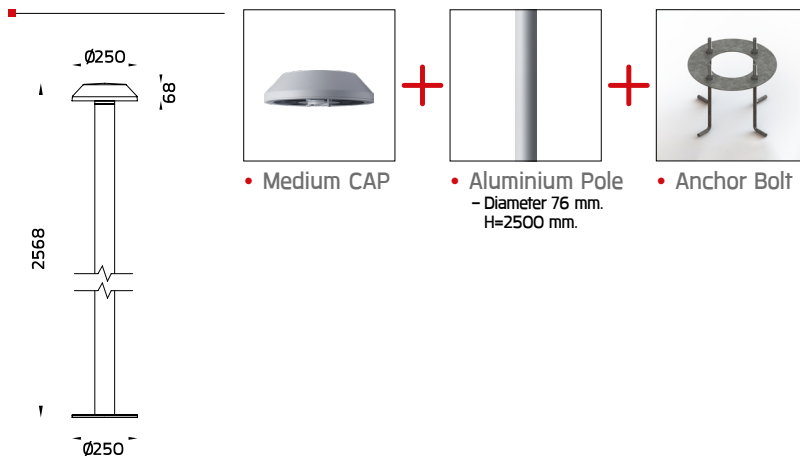
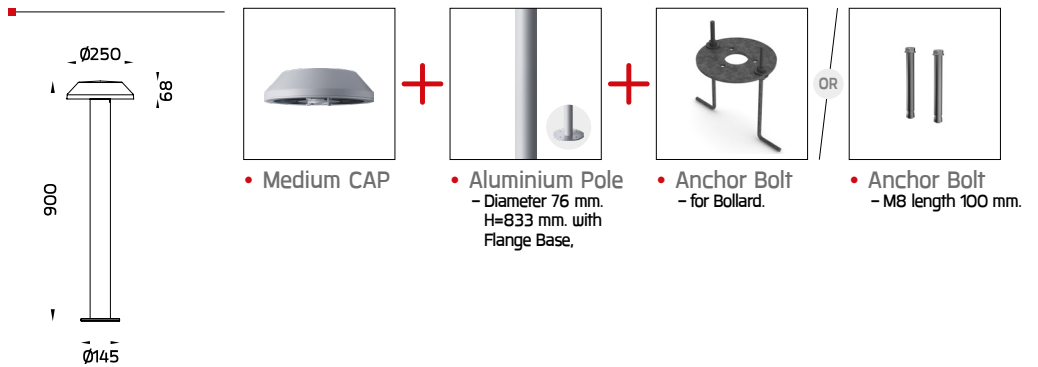

Pole Light Version



* Pole is not included and has to be ordered separately.



CAP

Product Code	Product Name	Luminaire Wattage	Beam	CCT	Luminaire Lumen	Controller	
OD-7177 	Mini CAP – Bollard Flange Base	7 W	N/A	2700 K 3000 K 4000 K	640 lm 670 lm 720 lm	On-Off On-Off On-Off	
		9 W	N/A	2700 K 3000 K 4000 K	930 lm 950 lm 1010 lm	On-Off On-Off On-Off	
		7 W	N/A	2700 K 3000 K 4000 K	640 lm 670 lm 720 lm	Remote driver CV On-Off / DALI Remote driver CV On-Off / DALI Remote driver CV On-Off / DALI	
	OD-7178 	Mini CAP – Short Bollard Flange Base	7 W	N/A	2700 K 3000 K 4000 K	640 lm 670 lm 720 lm	On-Off On-Off On-Off
			9 W	N/A	2700 K 3000 K 4000 K	930 lm 950 lm 1010 lm	On-Off On-Off On-Off
		Mini CAP – Short Bollard Flange Base CVDA	7 W	N/A	2700 K 3000 K 4000 K	640 lm 670 lm 720 lm	Remote driver CV On-Off / DALI Remote driver CV On-Off / DALI Remote driver CV On-Off / DALI
OD-7877 	Mini CAP – Bollard Root Mount Base	7 W	N/A	2700 K 3000 K 4000 K	640 lm 670 lm 720 lm	On-Off On-Off On-Off	
		9 W	N/A	2700 K 3000 K 4000 K	930 lm 950 lm 1010 lm	On-Off On-Off On-Off	
	Mini CAP – Bollard Root Mount Base CVDA	7 W	N/A	2700 K 3000 K 4000 K	640 lm 670 lm 720 lm	Remote driver CV On-Off / DALI Remote driver CV On-Off / DALI Remote driver CV On-Off / DALI	
		7 W	N/A	2700 K 3000 K 4000 K	640 lm 670 lm 720 lm	Remote driver CV On-Off / DALI Remote driver CV On-Off / DALI Remote driver CV On-Off / DALI	
OD-7878 	Mini CAP – Short Bollard Root Mount Base	7 W	N/A	2700 K 3000 K 4000 K	640 lm 670 lm 720 lm	On-Off On-Off On-Off	
		9 W	N/A	2700 K 3000 K 4000 K	930 lm 950 lm 1010 lm	On-Off On-Off On-Off	
	Mini CAP – Short Bollard Root Mount Base CVDA	7 W	N/A	2700 K 3000 K 4000 K	640 lm 670 lm 720 lm	Remote driver CV On-Off / DALI Remote driver CV On-Off / DALI Remote driver CV On-Off / DALI	
		7 W	N/A	2700 K 3000 K 4000 K	640 lm 670 lm 720 lm	Remote driver CV On-Off / DALI Remote driver CV On-Off / DALI Remote driver CV On-Off / DALI	
OD-7879 	Medium CAP 90 – Head	11 W	T2	2700 K	710 lm	On-Off / 1-10V / DALI / CASAMBI	
				3000 K	710 lm	On-Off / 1-10V / DALI / CASAMBI	
				4000 K	760 lm	On-Off / 1-10V / DALI / CASAMBI	
		16 W	T2	2700 K	1030 lm	On-Off / 1-10V / DALI / CASAMBI	
				3000 K	1030 lm	On-Off / 1-10V / DALI / CASAMBI	
				4000 K	1090 lm	On-Off / 1-10V / DALI / CASAMBI	
		19 W	T2	2700 K	1340 lm	On-Off / 1-10V / DALI / CASAMBI	
				3000 K	1340 lm	On-Off / 1-10V / DALI / CASAMBI	
				4000 K	1430 lm	On-Off / 1-10V / DALI / CASAMBI	
		27 W	T2	2700 K	1860 lm	On-Off / 1-10V / DALI / CASAMBI	
				3000 K	1860 lm	On-Off / 1-10V / DALI / CASAMBI	
				4000 K	1990 lm	On-Off / 1-10V / DALI / CASAMBI	
11 W	T3	2700 K	710 lm	On-Off / 1-10V / DALI / CASAMBI			
		3000 K	710 lm	On-Off / 1-10V / DALI / CASAMBI			
		4000 K	760 lm	On-Off / 1-10V / DALI / CASAMBI			
	16 W	T3	2700 K	1030 lm	On-Off / 1-10V / DALI / CASAMBI		
			3000 K	1030 lm	On-Off / 1-10V / DALI / CASAMBI		
			4000 K	1090 lm	On-Off / 1-10V / DALI / CASAMBI		
19 W	T3	2700 K	1440 lm	On-Off / 1-10V / DALI / CASAMBI			
		3000 K	1440 lm	On-Off / 1-10V / DALI / CASAMBI			
		4000 K	1540 lm	On-Off / 1-10V / DALI / CASAMBI			
27 W	T3	2700 K	2010 lm	On-Off / 1-10V / DALI / CASAMBI			
		3000 K	2010 lm	On-Off / 1-10V / DALI / CASAMBI			
		4000 K	2150 lm	On-Off / 1-10V / DALI / CASAMBI			
OD-7880 	Medium CAP 180 – Head	19 W	T2	2700 K	1250 lm	On-Off / 1-10V / DALI / CASAMBI	
				3000 K	1250 lm	On-Off / 1-10V / DALI / CASAMBI	
				4000 K	1340 lm	On-Off / 1-10V / DALI / CASAMBI	
		30 W	T2	2700 K	1800 lm	On-Off / 1-10V / DALI / CASAMBI	
				3000 K	1800 lm	On-Off / 1-10V / DALI / CASAMBI	
				4000 K	1920 lm	On-Off / 1-10V / DALI / CASAMBI	
		19 W	T4	2700 K	1440 lm	On-Off / 1-10V / DALI / CASAMBI	
				3000 K	1440 lm	On-Off / 1-10V / DALI / CASAMBI	
30 W	T4	4000 K	1540 lm	On-Off / 1-10V / DALI / CASAMBI			
		2700 K	2070 lm	On-Off / 1-10V / DALI / CASAMBI			
		3000 K	2070 lm	On-Off / 1-10V / DALI / CASAMBI			
				4000 K	2200 lm	On-Off / 1-10V / DALI / CASAMBI	

Medium CAP Version.
* Pole is not included and has to be ordered separately.

CAP

Product Code	Product Name	Luminaire Wattage	Beam	CCT	Luminaire Lumen	Controller
OD-7881 	Medium CAP 360 – Head	18 W	T5	2700 K	1540 lm	On-Off / 1-10V / DALI / CASAMBI
				3000 K	1540 lm	On-Off / 1-10V / DALI / CASAMBI
				4000 K	1660 lm	On-Off / 1-10V / DALI / CASAMBI
		18 W	T5	2700 K	1650 lm	On-Off / 1-10V / DALI / CASAMBI
				3000 K	1650 lm	On-Off / 1-10V / DALI / CASAMBI
				4000 K	1770 lm	On-Off / 1-10V / DALI / CASAMBI
		26 W	T5	2700 K	2140 lm	On-Off / 1-10V / DALI / CASAMBI
				3000 K	2140 lm	On-Off / 1-10V / DALI / CASAMBI
				4000 K	2300 lm	On-Off / 1-10V / DALI / CASAMBI
		26 W	T5	2700 K	2290 lm	On-Off / 1-10V / DALI / CASAMBI
				3000 K	2290 lm	On-Off / 1-10V / DALI / CASAMBI
				4000 K	2470 lm	On-Off / 1-10V / DALI / CASAMBI
		22 W	N/A	2700 K	2360 lm	On-Off / 1-10V / DALI / CASAMBI
				3000 K	2460 lm	On-Off / 1-10V / DALI / CASAMBI
				4000 K	2590 lm	On-Off / 1-10V / DALI / CASAMBI
		32 W	N/A	2700 K	3280 lm	On-Off / 1-10V / DALI / CASAMBI
				3000 K	3380 lm	On-Off / 1-10V / DALI / CASAMBI
				4000 K	3600 lm	On-Off / 1-10V / DALI / CASAMBI

Medium CAP Version.

* Pole is not included and has to be ordered separately.



Application Reference



Unilamp Co., Ltd.

461 Ramintra Road, Kannayao, Bangkok 10230 Thailand

Tel : +66[0]2 943 2420-1, +66[0]2 946 4170-1

Fax : +66[0]2 943 2419

unilamp@unilamp.co.th | online@unilamp.co.th

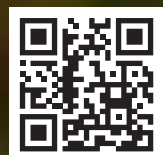

www.unilamp.co.th