

Quality light for the outdoors: complete your project with the right landscape lighting. Advanced technology meets discreet design.

YORI IP66

Reggiani

Reggiani

Contents

Yori IP66	17
Yori IP66 Surface/Pendant	57
Yori IP66 Wall	75
Finishes	89

It's time to g

go outdoors

EN Yori IP66 is the brand new system of lighting products for your landscape projects. The Yori projectors family has evolved and widened, now with IP66 rating. Advanced technology meets discreet design, quality light for the outdoors.

IT Yori IP66 è il nuovo sistema di prodotti di illuminazione per i tuoi progetti landscape. La famiglia di proiettori Yori si è evoluta e allargata, ed è ora disponibile in IP66. Tecnologia all'avanguardia in un design pulito e minimale, luce di qualità per gli ambienti esterni.



Yori IP66





Simply reliable

EN The high quality materials, the IP66 rating and its "No-risk" technology, make Yori IP66 system the ideal solution for quality lighting, in any weather condition.

IT I materiali selezionati, il grado IP66 e la sua tecnologia "No-risk", rendono il sistema Yori IP66 la soluzione ideale per un'illuminazione di qualità qualunque siano le condizioni atmosferiche.



EN “No-risk” technology is a protection integrated system that provides full safety to the LED source and all the electronics components of the Yori IP66.

IT “No-risk” technology è un sistema di protezione integrato nel prodotto che garantisce completa sicurezza alla sorgente LED e alle componenti elettroniche di Yori IP66.

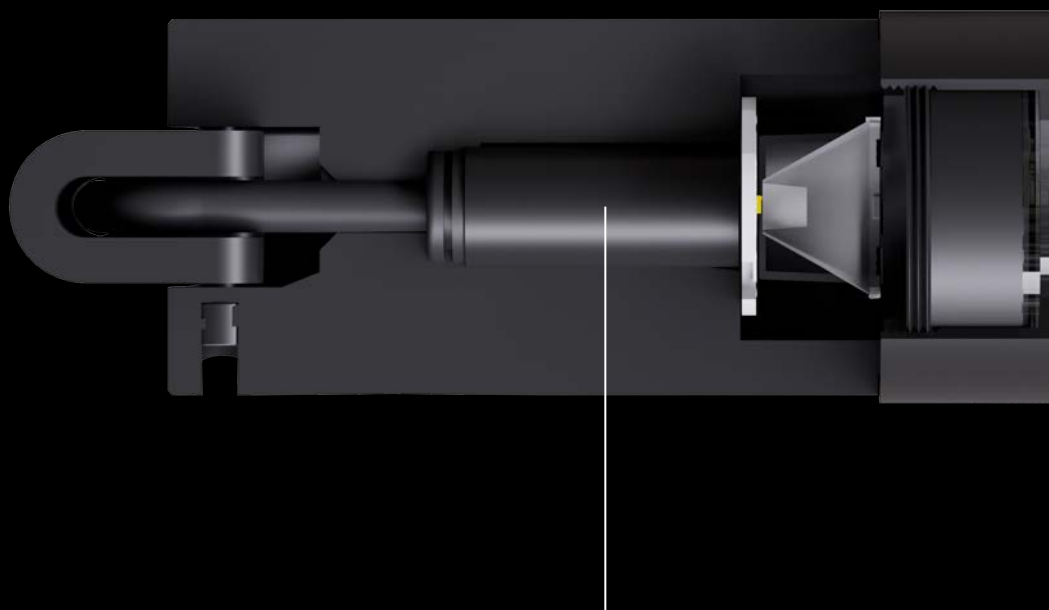

EN Full protection from:

- polarity inversion: a diode prevents accidental damage to the product during accidental reverse polarity installation.
- spikes of the input voltage: a fully integrated spike-reduction prevents damage to the LED. A High Voltage (HV) LED driver guarantees normal operation during transient spikes of the input voltage.
- water: a barrier preventing potential ingress of water from the cable entry due to the capillary action effect.
- system anomalies: in the unlikely event of other faults, an integrated fuse protection prevents issues caused on the installed chain of products.

IT Completa protezione da:

- inversione di polarità: un diodo interno previene danni all'apparecchio dovuti ad accidentali installazioni con i poli invertiti.
- picchi di tensione in ingresso: un soppressore di picchi di tensione, completamente integrato, previene la rottura del LED. Un driver LED High Voltage (HV) garantisce un normale funzionamento anche con picchi transitori sulla tensione d' ingresso.
- acqua: una barriera interna impedisce il potenziale ingresso di acqua dal cavo per effetto della capillarità dei fili conduttori.
- anomalie di sistema: nel caso remoto di ulteriori anomalie al sistema, un fusibile di protezione integrato previene problemi sulla linea.

Ecofriendly

^{EN} Developed for the outdoors, with attention to the environment.

In compliance with the Eco-Design Regulation (EU) 2019/2020, the light source of Yori IP66 and its power supply unit can be separated to guarantee the repairability of the product in case of failure and/or replacement of components to allow for any upgrades where more efficient or otherwise better options become available in the near future. Furthermore, the anodization treatment that the aluminium undergoes is an environmentally friendly process, not using dangerous or carcinogenic substances such as heavy metals or solvents. The coating is mainly composed of aluminium oxide, an inert and non-hazardous material.

^{IT} Sviluppato per gli esterni, con attenzione all'ambiente.

In ottemperanza alla normativa Eco-Design Regolamento (UE) 2019/2020 la sorgente luminosa di Yori IP66 e la sua unità di alimentazione, sono separabili per garantire la riparabilità del prodotto in caso di guasto e/o sostituibili per consentire l'eventuale aggiornamento/implementazione del prodotto, laddove componenti più efficienti o comunque migliori siano disponibili in un prossimo futuro.

Inoltre, il trattamento di anodizzazione che subisce l'alluminio è un processo rispettoso dell'ambiente, non utilizzando sostanze pericolose o cancerogene quali metalli pesanti o solventi. Il rivestimento è composto prevalentemente da ossido di alluminio, materiale inerte e non pericoloso.



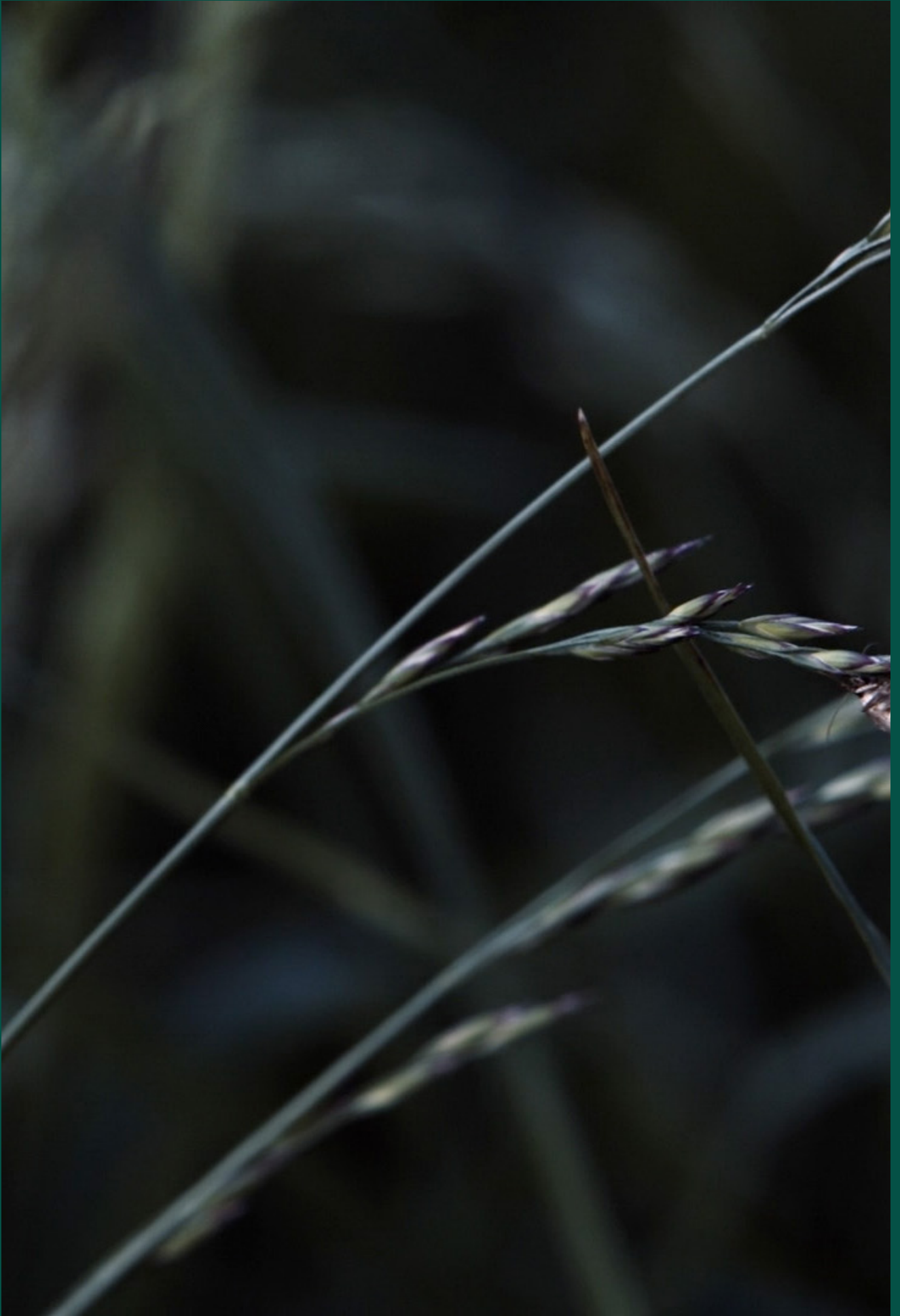

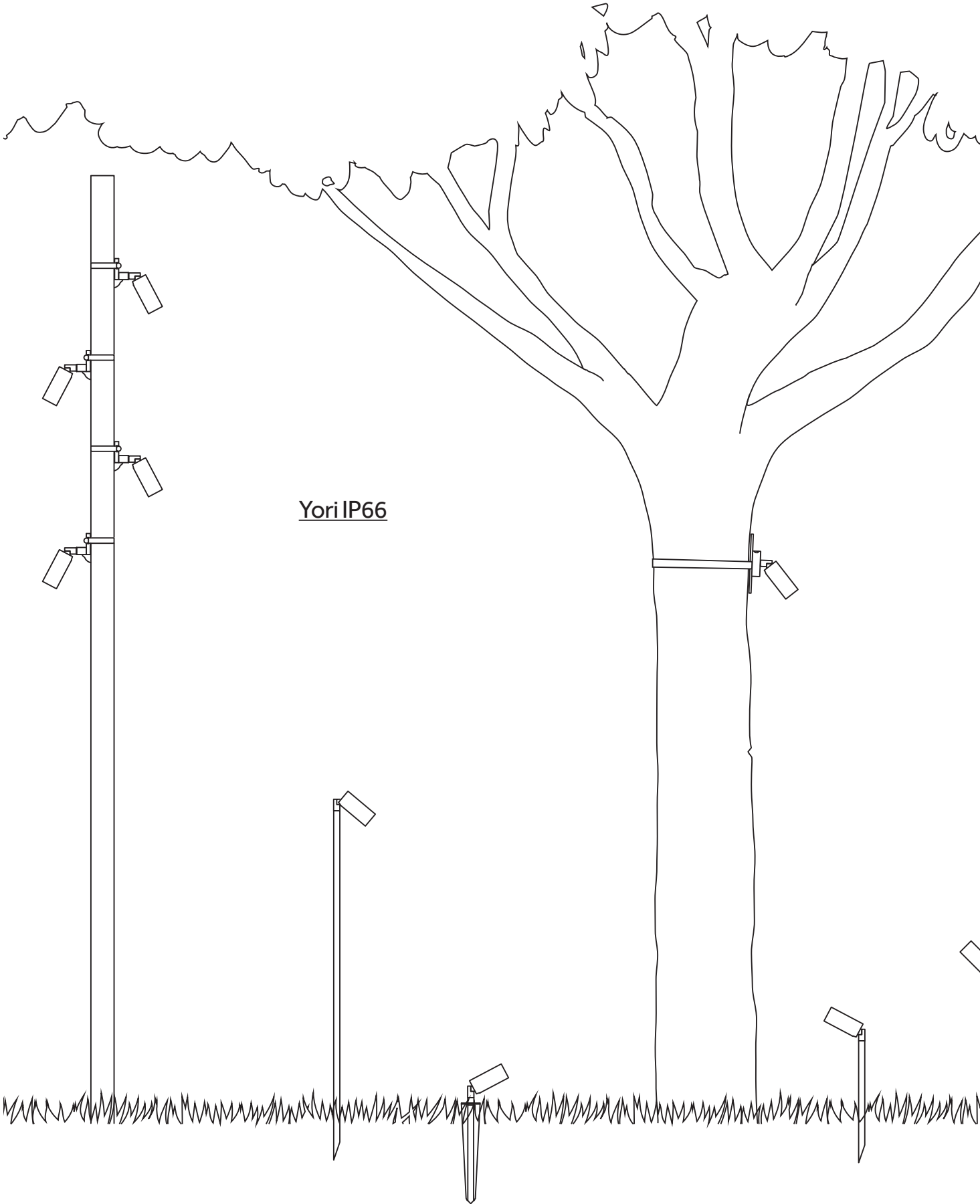

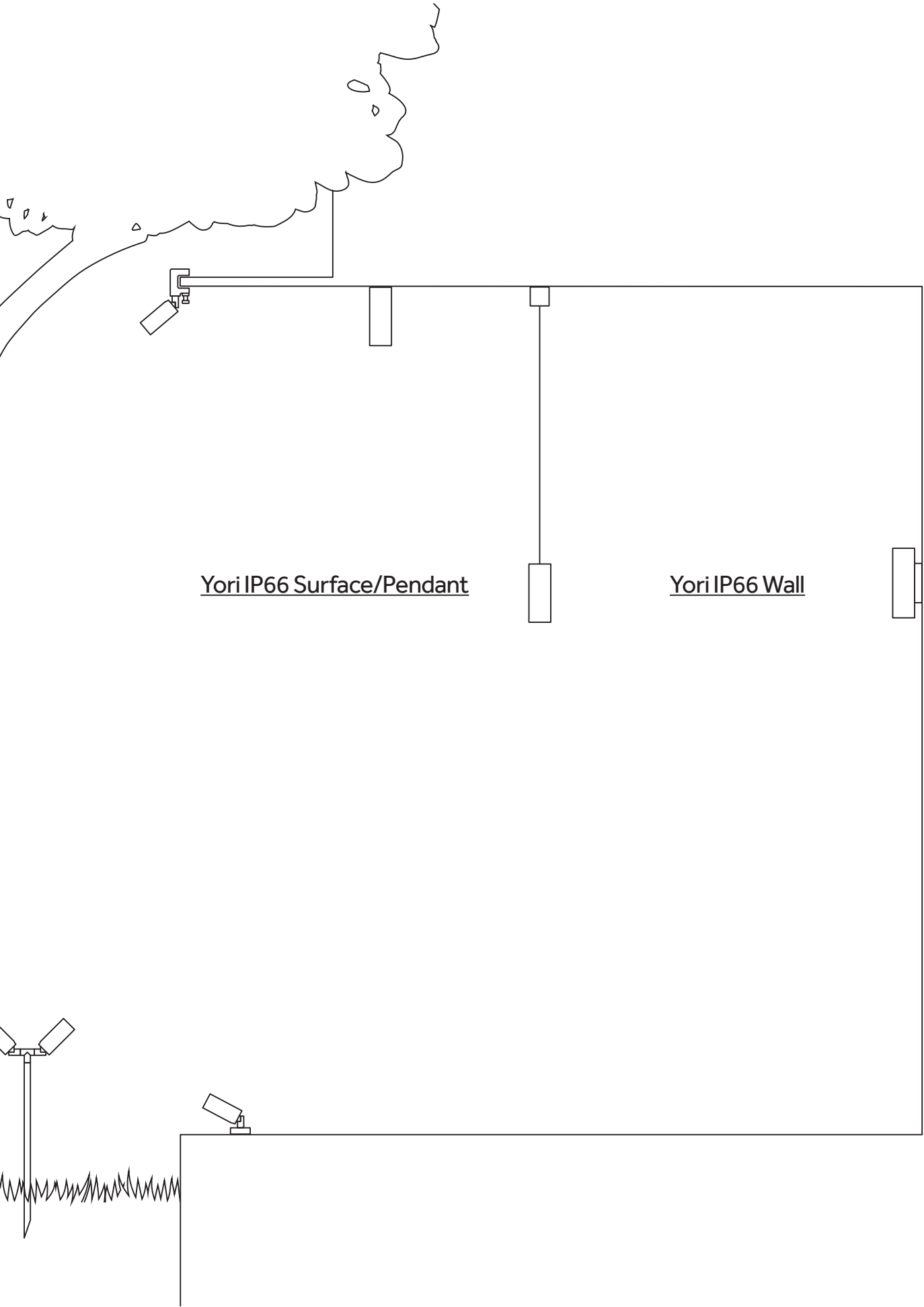



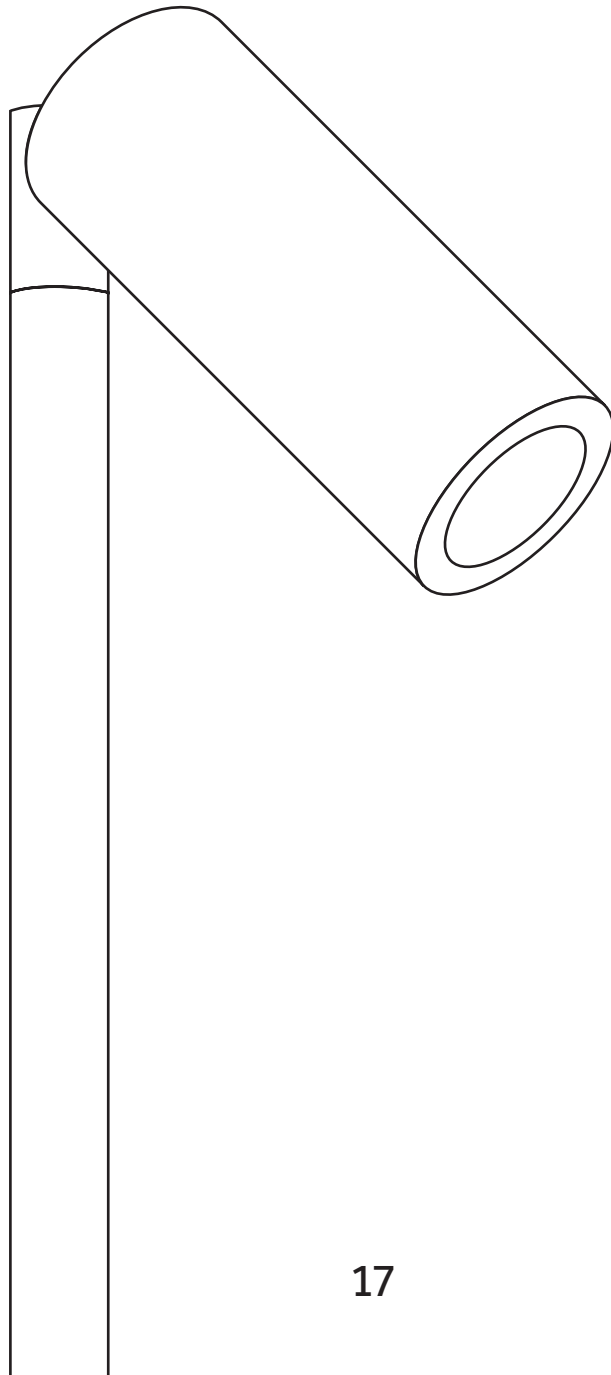



Yori IP66



EN Designed to fulfill any requirement in high-end landscape contemporary projects, Yori IP66 is the outdoor version of our Yori projector. Minimal, elegant design, sophisticated finishes and a wide selection of accessories, beautifully integrate the product range into any project.

IT Progettato per soddisfare qualsiasi esigenza in progetti landscape contemporanei di fascia alta, Yori IP66 è la versione per esterni del nostro proiettore Yori. Design minimale ed elegante e finiture sofisticate, integrano magnificamente la gamma in qualsiasi progetto. L'ampia gamma di accessori rende Yori IP66 estremamente versatile e adatto a diversi ambienti e dettagli architettonici.

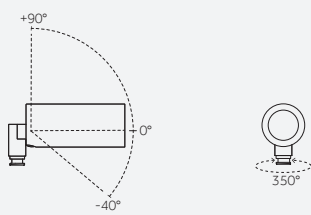

Versions/ Versioni				
Yori IP66				
Finishes/ Finiture				
Special finishes/ Finiture speciali				
Adjustability/ Orientabilità				
IP / IK	66 / 07			
Control systems	On/Off; DALI; 1-10V; PUSH; DMX			
Insulation class				
Certifications				

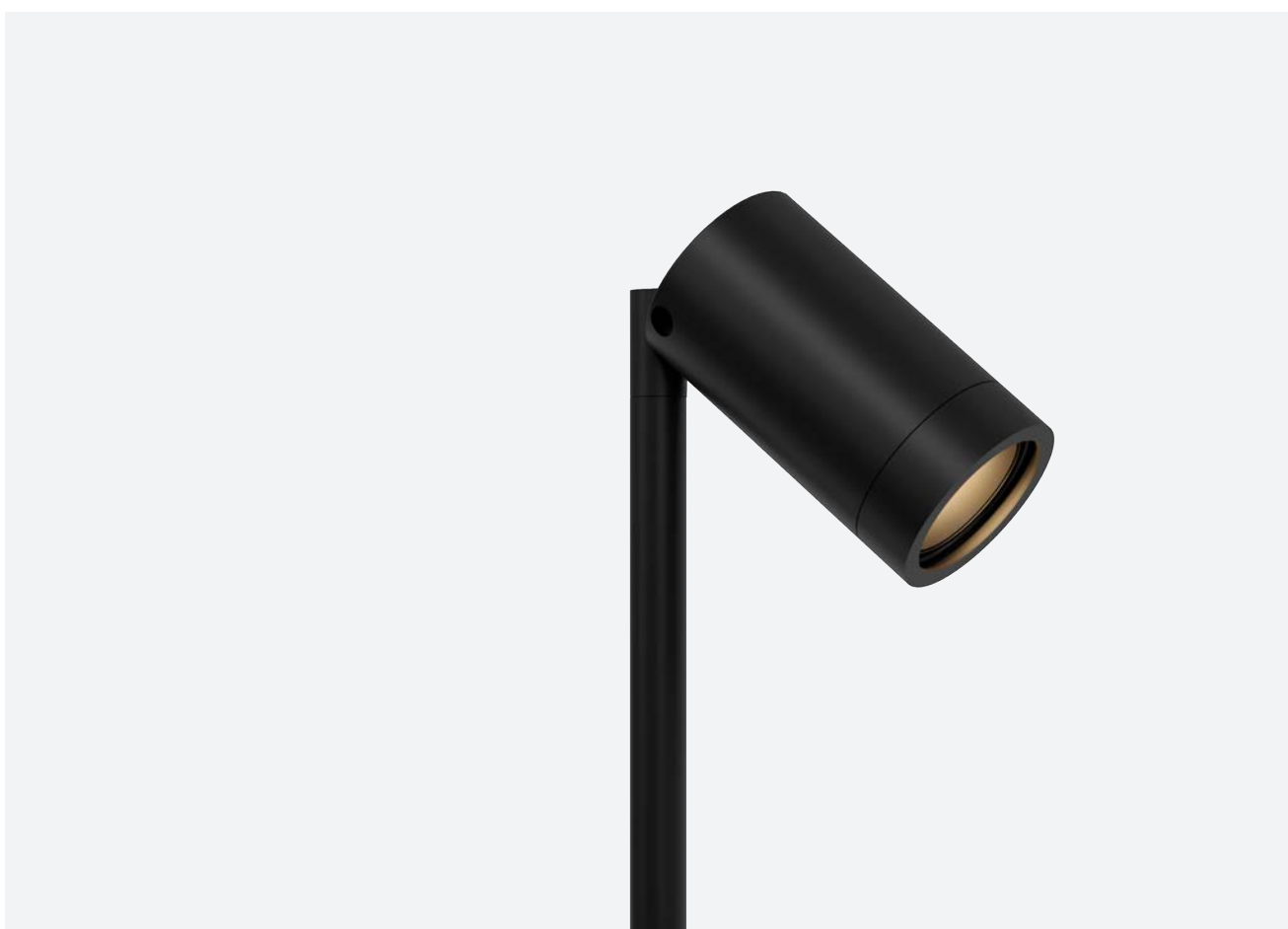
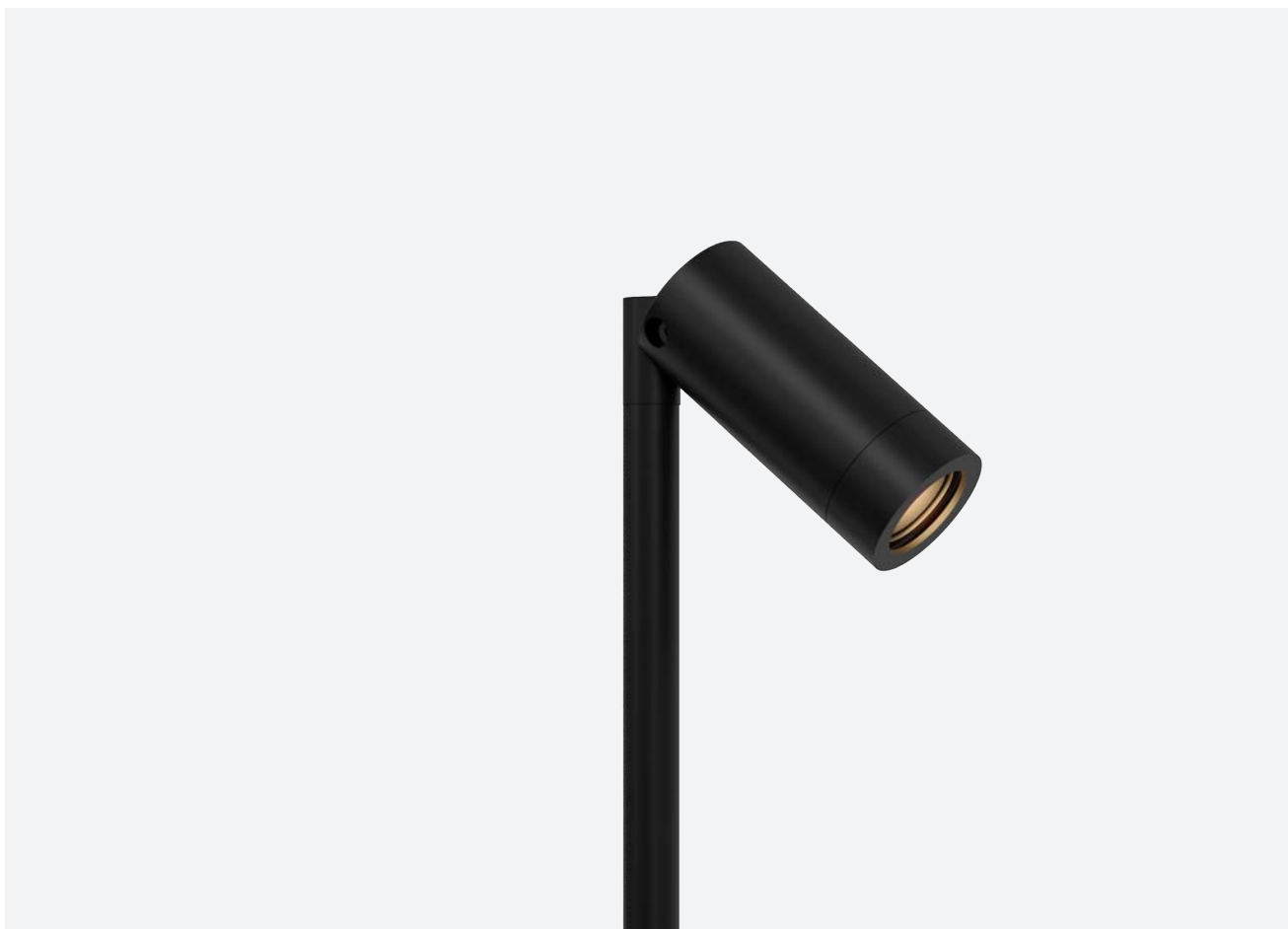

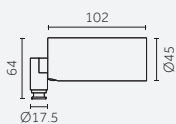
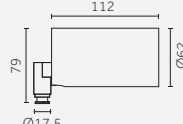
	Ø 45 mm	Ø 60 mm
Yori IP66	 <p>p.46</p>	 <p>p.46</p>
△	8°; 12°; 26°; 38°; 10°x40°; 40°x10°	11°; 17°; 29°; 35°; 20°x50°; 50°x20°
Light source/ Sorgente luminosa	<p>POWER LED 2 W; 3,2 W 178 lm - 283 lm L80 B10=50,000 h 2700 K; 3000 K; 4000 K SDCM <3 CRI >90</p>	<p>POWER LED 4,5 W; 7 W; 12 W 605 lm - 1449 lm L80 B10=50,000 h 2700 K; 3000 K; 4000 K SDCM <3 CRI >90</p> <p>Warm Dimming COB LED 11,8 W 35 lm - 1246 lm L70 B10=50,000 h 1800 K - 3000 K SDCM <4 CRI >90</p>

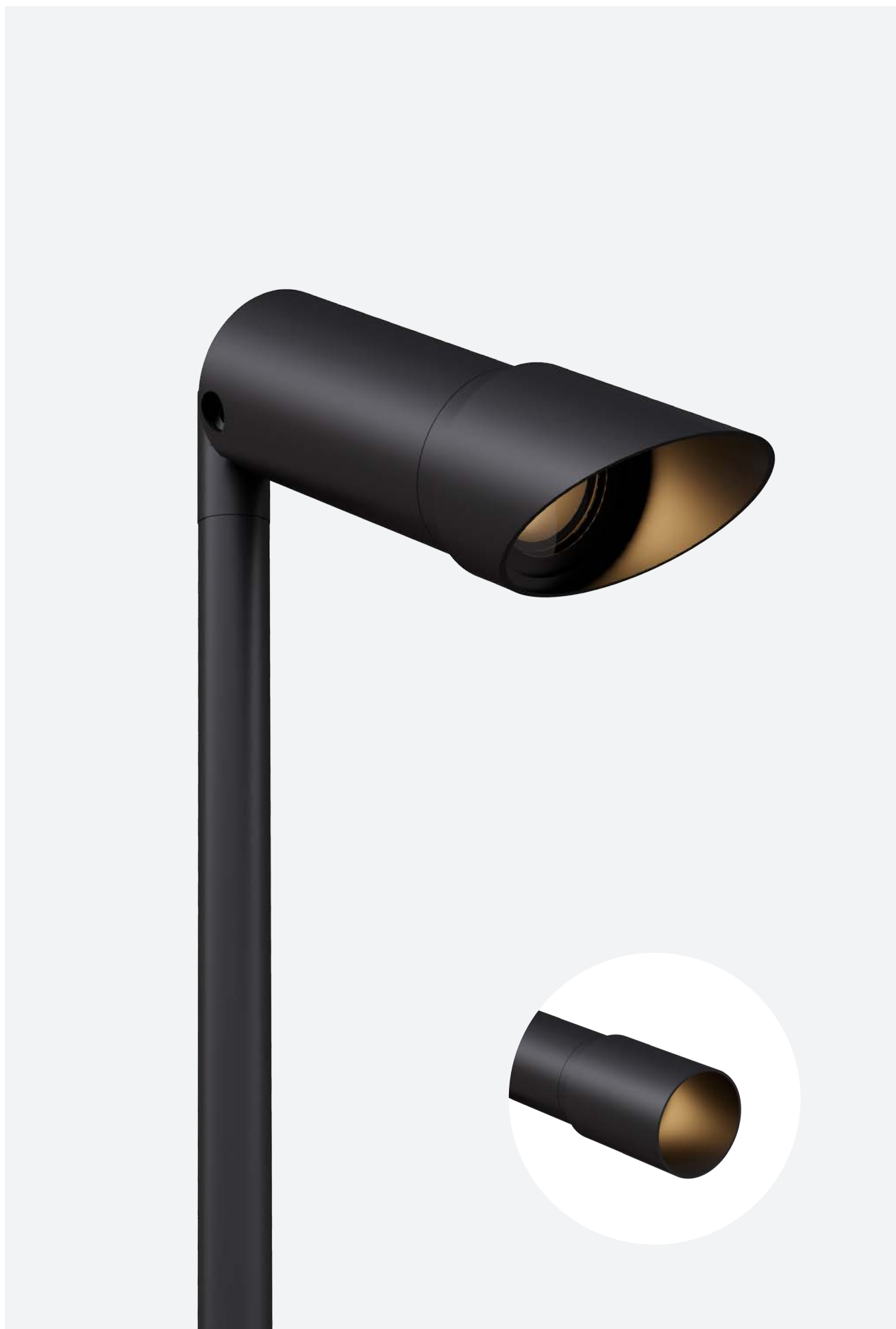

EN Yori IP66 has two alternative snoots: a cylindrical snoot for an even more controlled light beam and a 45° snoot, to minimize upward light spillage.

IT Yori IP66 dispone, come accessori, di due snoot alternativi: cilindrico per un fascio di luce ancora più controllato e snoot a 45° per ridurre al minimo lo spillage luminoso verso l'alto.



EN Snoot 45° (Ø45)
IT Snoot 45° (Ø45)

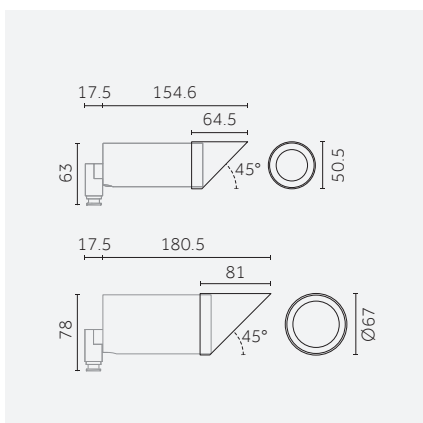

EN Snoot 45° available for Ø45 and Ø60 version
IT Snoot 45° disponibile nelle versioni Ø45 e Ø60



EN Snoot (Ø45)
IT Snoot (Ø45)

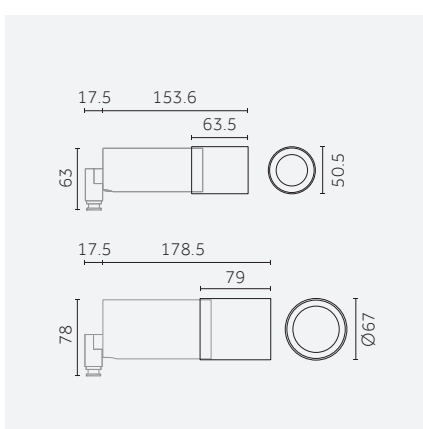

EN Snoot available for Ø45 and Ø60 version
IT Snoot disponibile nelle versioni Ø45 e Ø60

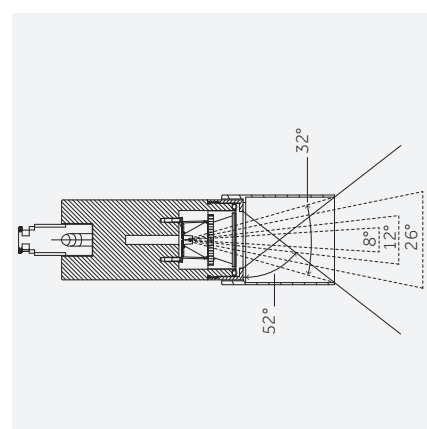

- **8D** Black anodized/
Anodizzato nero
- **8F** Antiqued bronze (solid brass)/
Bronzo anticato (ottone massiccio)

Place it (almost) wherever you want

EN Complete Yori IP66 with the accessory that best suits your project. Its universal "lock-hinge" allows you to adapt both projectors (Ø45 or Ø60) to a wide range of fixing accessories, from the stakes to the tree strap.

IT Completa Yori IP66 con l'accessorio migliore per il tuo progetto. La sua "cerniera di bloccaggio" universale consente di adattare entrambi i proiettori (Ø45 o Ø60) ad un'ampia gamma di accessori di fissaggio, dai picchetti alla cinghia per alberi.



Ø45



Ø60





^{EN} The finish of the accessory follows the finish of the product. If not available, the standard finish is 8D (black anodized)

^{IT} La finitura dell'accessorio segue la finitura del prodotto. Se non disponibile, la finitura standard è 8D (anodizzato nero).



EN A wide range of spikes for ground applications. The version with anti-rotation is ideal for walkways and gardens, guaranteeing stability and preventing any movement due to external agents.

IT Ampia gamma di picchetti per applicazioni a terra. La versione con antirotazione, ideale per camminamenti e giardini, impedisce eventuali spostamenti e rotazioni dovuti ad agenti esterni.

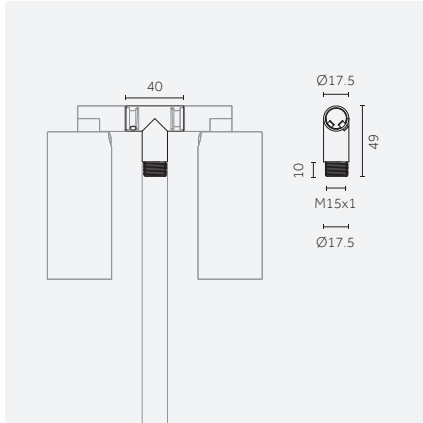

- 8D** Black anodized/
Anodizzato nero
- 8F** Antiqued bronze (solid brass)/
Bronzo anticato (ottone massiccio)

EN Double head for projectors
IT Testa doppia per proiettori

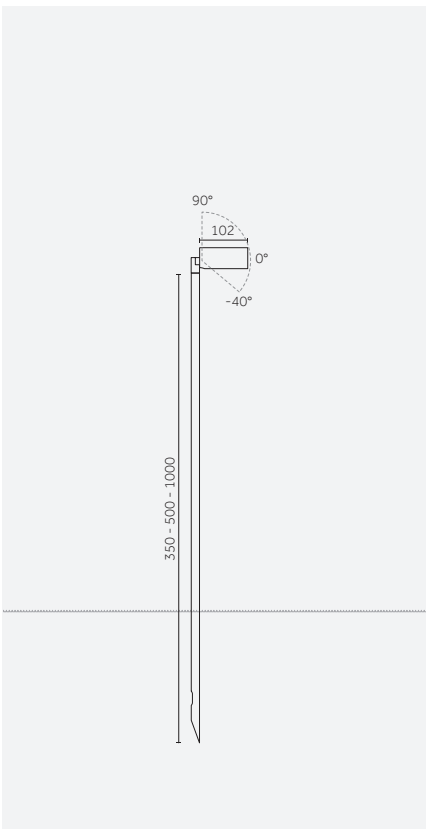

EN Spike (350, 500, 1000 mm)
IT Picchetto (350, 500, 1000 mm)

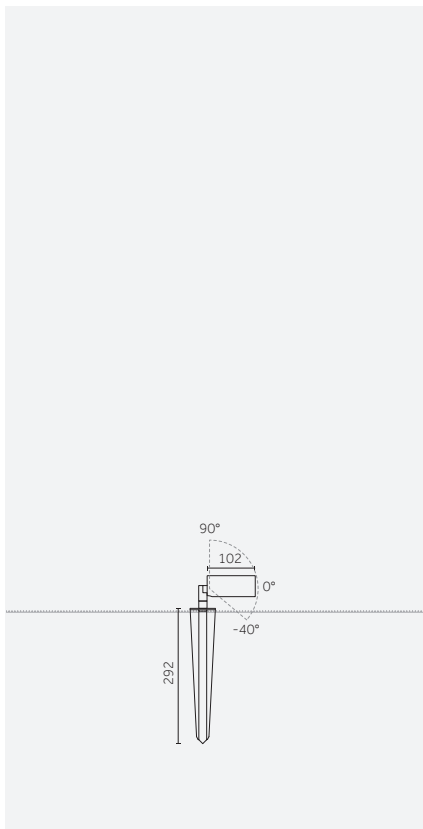

EN Antirotation
IT Antirotazione

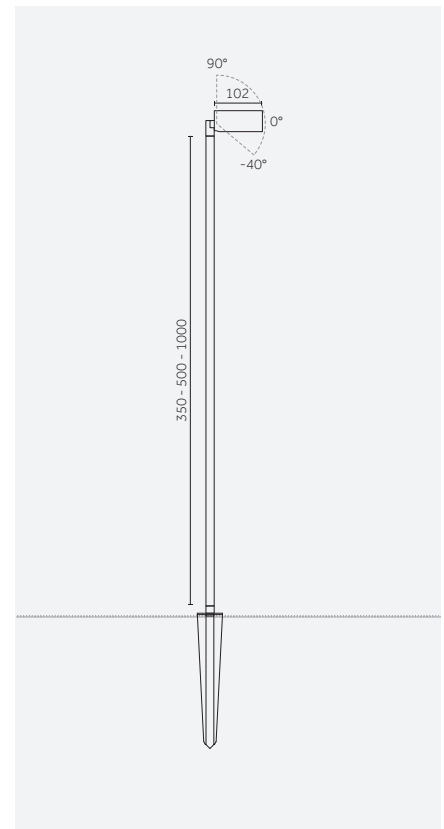

EN Antirotation + tubular (350, 500, 1000 mm)
IT Antirotazione + tubolare (350, 500, 1000 mm)

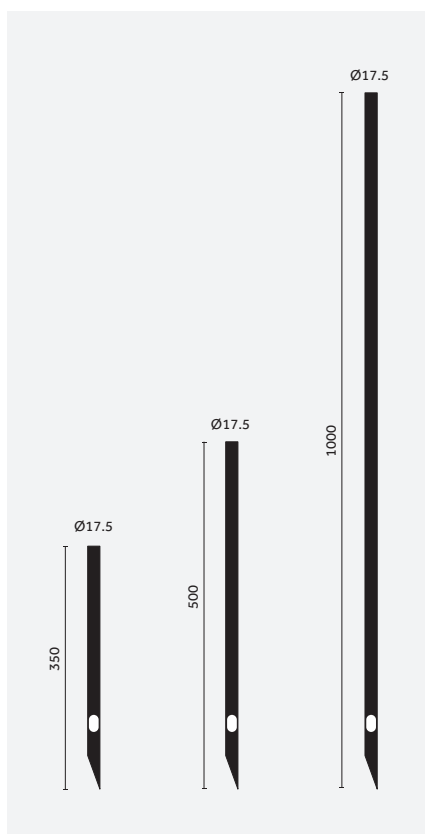
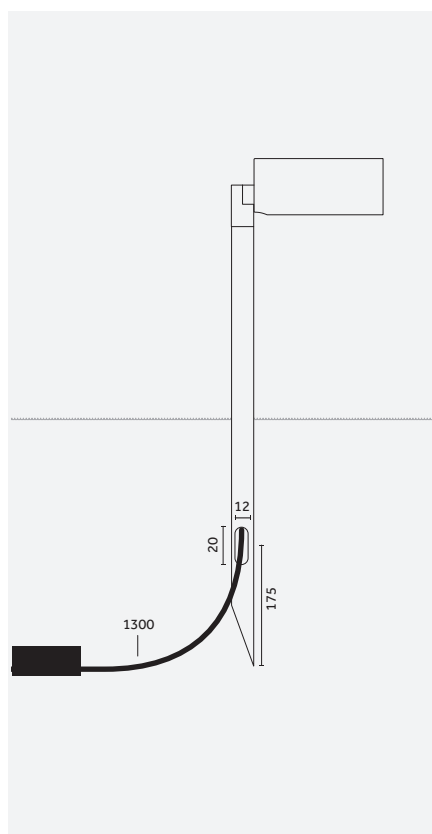
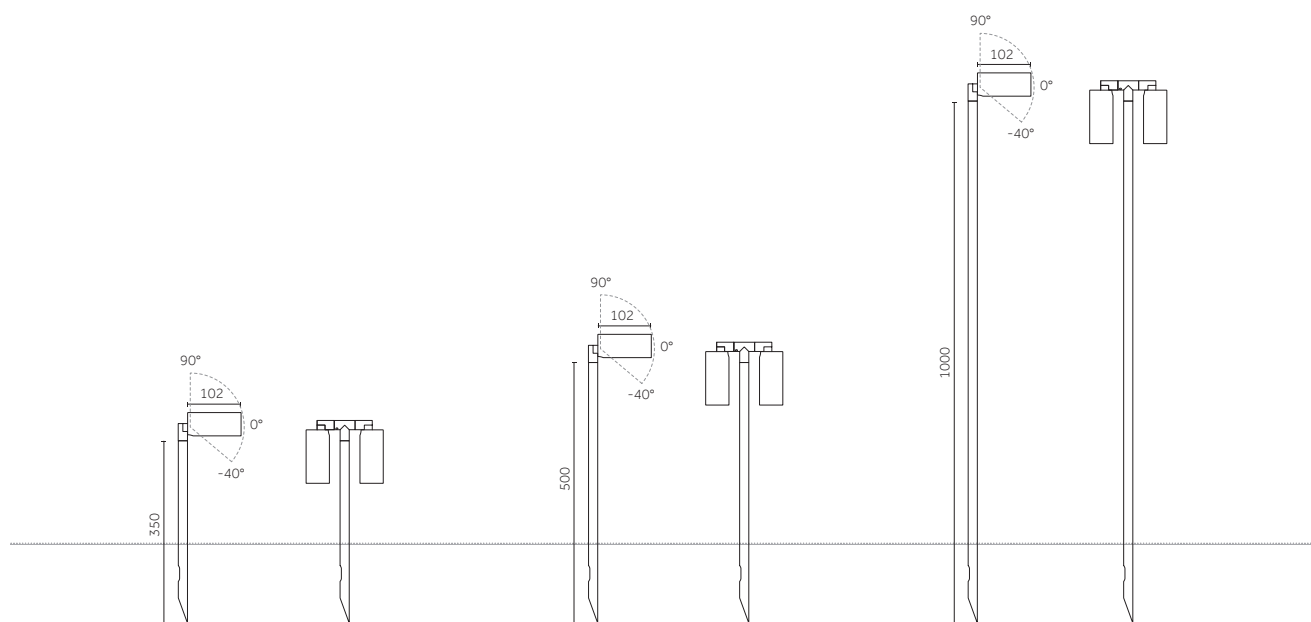

EN Cable length: 1,3m - Driver and connectors: p.52-55
IT Lunghezza cavo: 1,3m - Driver e connettori: p.52-55

EN Spike gamma
IT Gamma di picchetti

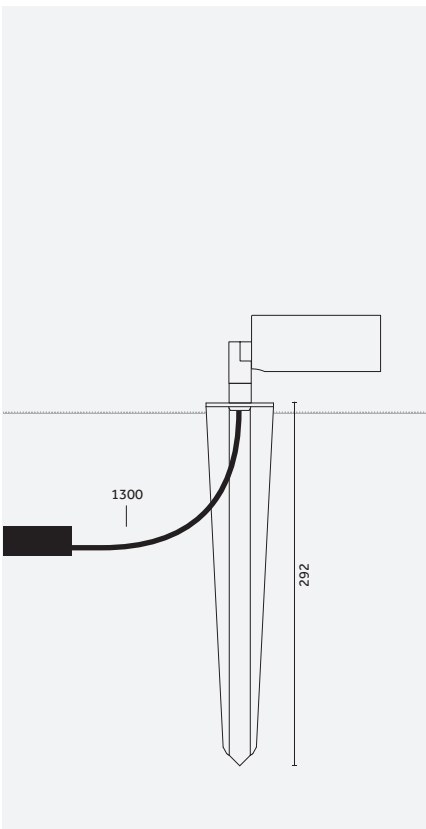
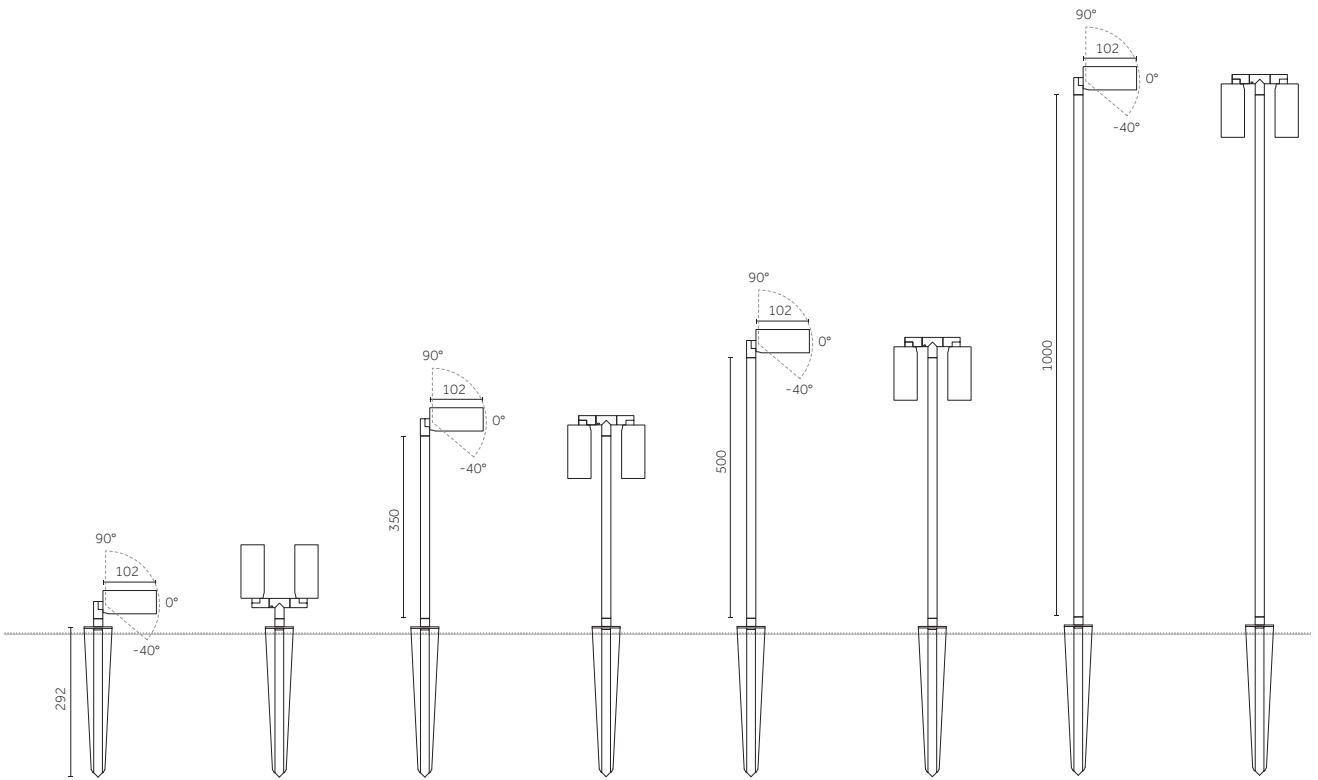

EN Cable length: 1,3m - Driver and connectors: p.52-55
 IT Lunghezza cavo: 1,3m - Driver e connettori: p.52-55

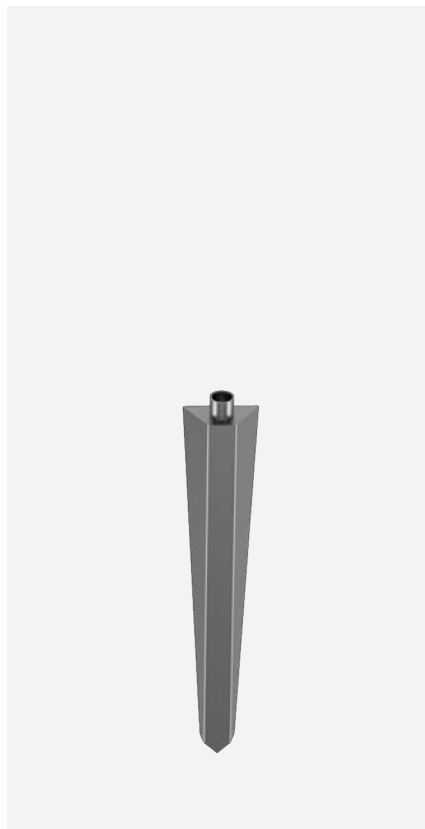

EN Antirotation
 IT Antirotazione

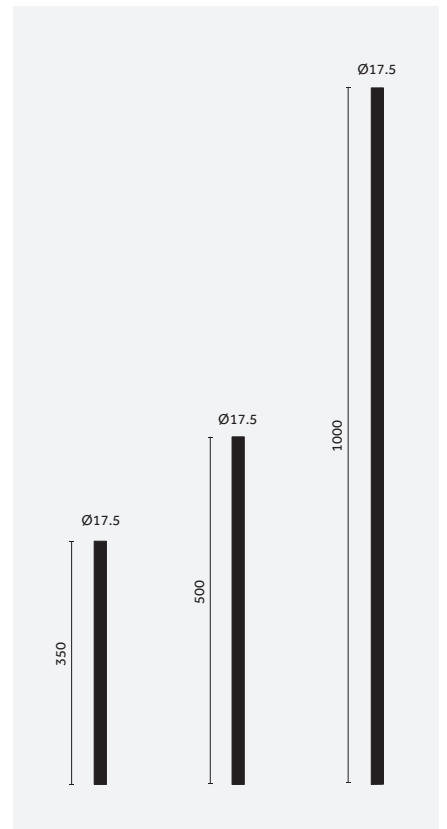

EN Tubulars in 3 different heights
 IT Tubolari in 3 diverse altezze



^{EN} Total cable protection thanks to the inner built-in groove.

^{IT} Totale protezione del cavo grazie allo slot interno.

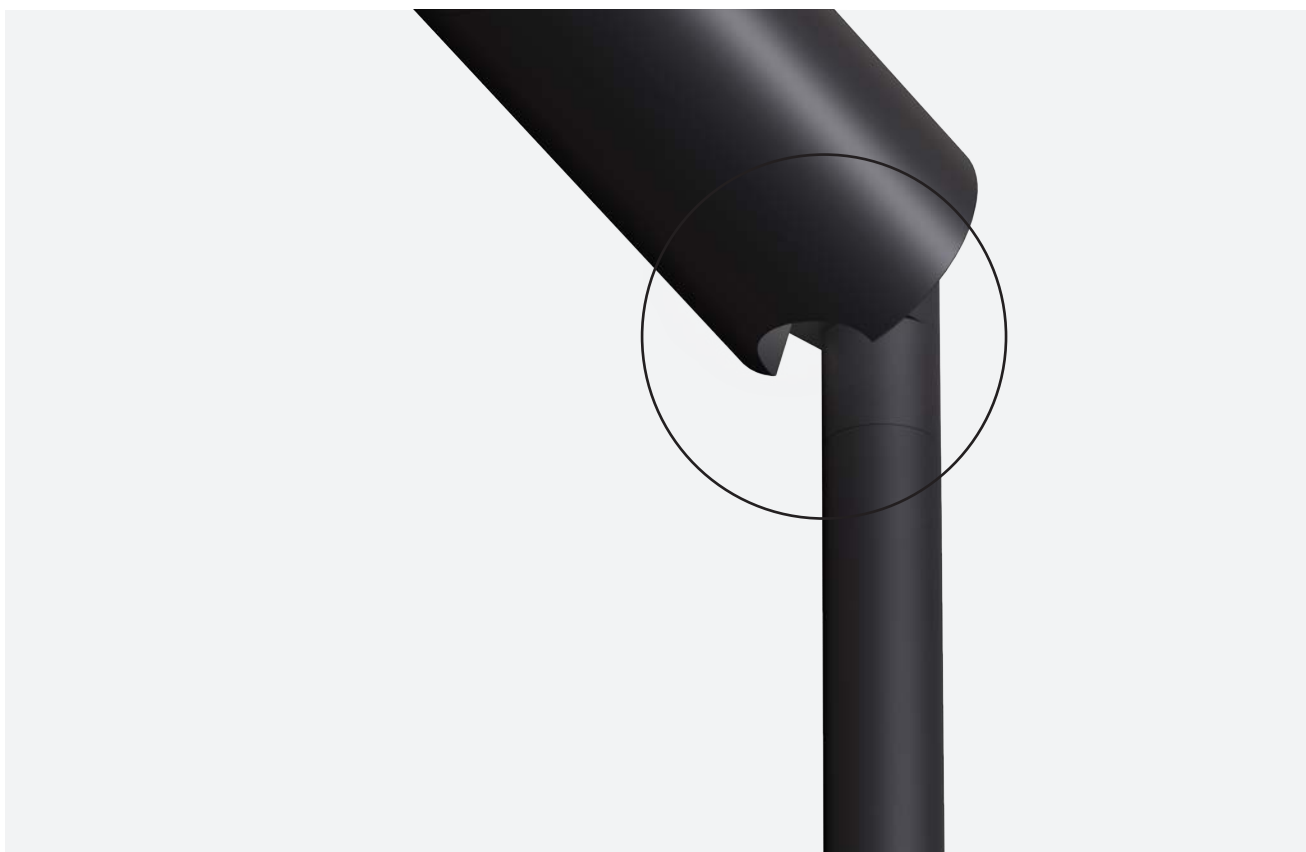

^{EN} Side slot to allow negative adjustment: -40° from the horizontal plane

^{IT} Fessura laterale per permettere orientamento negativo: -40° sull'asse orizzontale

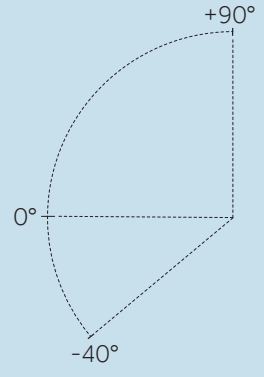



EN Two different bases available for surface mountings. A standard base with rear cable entry and a base with side cable entry for rigid materials or not pierceable surfaces.

IT Disponibili due diverse basi per il montaggio a superficie. Base standard con ingresso cavi posteriore e base per ingresso cavi laterale per materiali rigidi o superfici non perforabili.

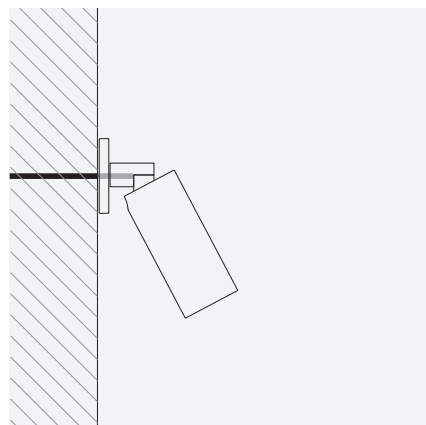
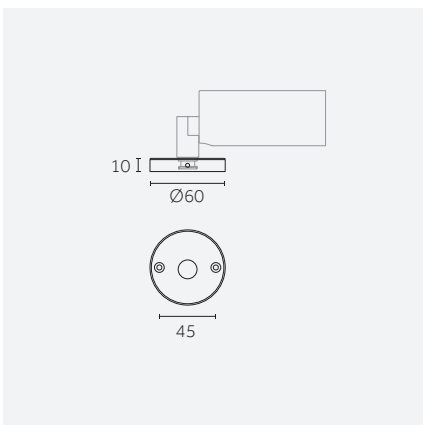

EN Base with rear cable entry

IT Basetta per cablaggio con entrata posteriore

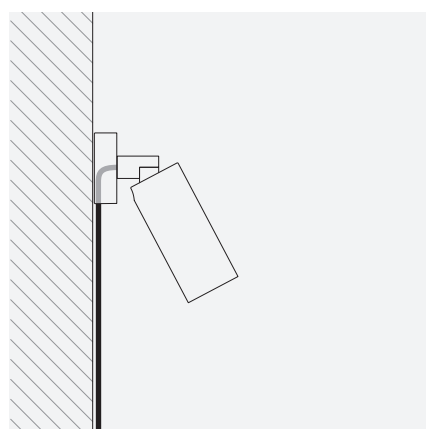
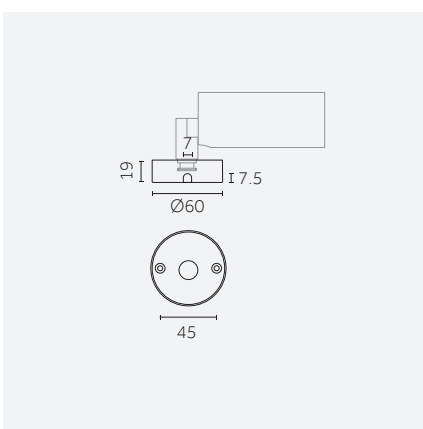

EN Base with side cable entry

IT Basetta per cablaggio con entrata laterale

- 8C Raw anodized/
Anodizzato naturale
- 8D Black anodized/
Anodizzato nero
- 8E Stainless steel (AISI 316)/
Acciaio inox (AISI 316)
- 8F Antiqued bronze (solid brass)/
Bronzo anticato (ottone massiccio)
- 9D Copper/
Rame

- 9F Champagne anodized/
Anodizzato champagne
- 9M Antiqued bronze/
Bronzo anticato
- 9N Olive green/
Verde oliva
- 9P Corten/
Corten
- 9Q Titanium/
Titanio

EN If not specified, accessories are made of aluminium
IT Se non specificato, gli accessori sono in alluminio



EN Clamp for beams and structural bars with thicknesses up to 27mm.
Feed-through cable integrated in the clamp for clean fixing.

IT Clamp per fissaggio a travi e barre strutturali con spessori fino a 27mm.
Cavo di alimentazione passante e integrato nel morsetto per un'installazione pulita.

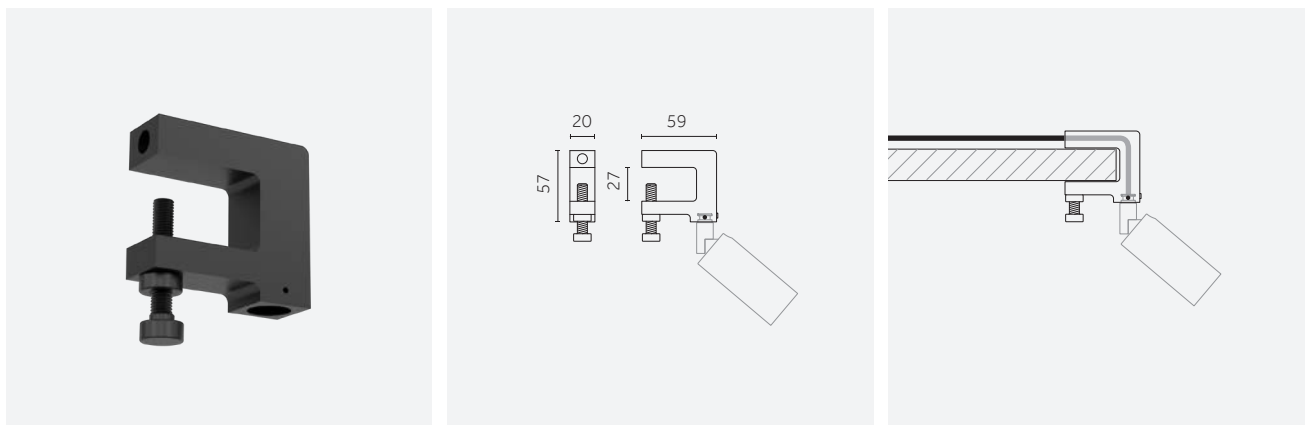

EN Beam clamp
IT Clamp per travi



EN Accessory for fixing Yori IP66 to tree branches/trunks, with an elongated base to ensure complete stability and precise aiming.

IT Accessorio per fissaggio a rami/tronchi d'albero, con base allungata per garantire completa stabilità e puntamenti precisi.

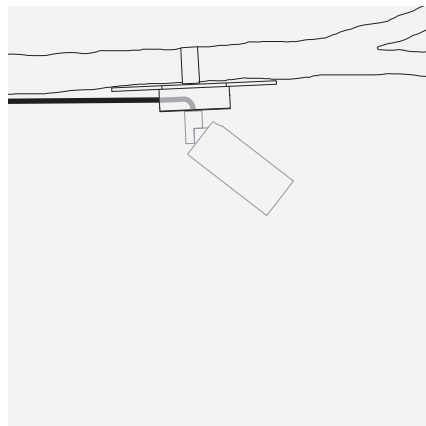
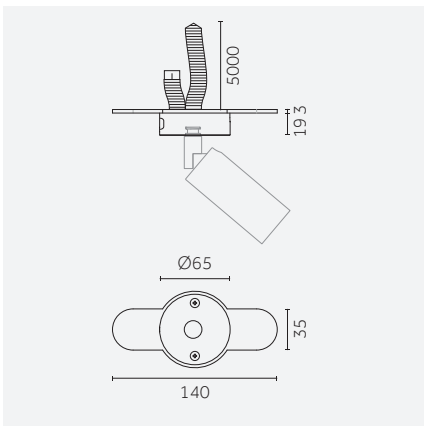

EN Tree strap with side cable entry.

IT Fascia per rami con passaggio cavo laterale.

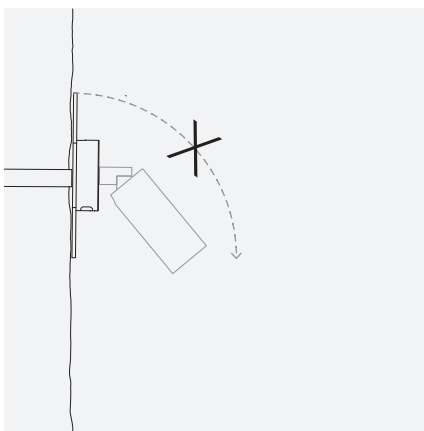

EN The elongated base guarantees stability and reduces the torsion / moment effect created by the weight of the product

IT La basetta allungata garantisce stabilità e riduce l'effetto torsione/momento creato dal peso del prodotto

■ **8D** Black anodized/
Anodizzato nero

■ **8F** Antiqued bronze (solid brass)/
Bronzo anticato (ottone massiccio)



EN The "tube clamp" accessory, thanks to the extendable stainless steel clamp, allows the mounting of Yori IP66 on structural pipes of different diameters (from Ø15 to Ø70).

IT L'accessorio "tube clamp", grazie alla sua fascetta in acciaio inox allungabile, permette il montaggio di Yori IP66 su tubi strutturali di diversi diametri (da Ø15 a Ø70).

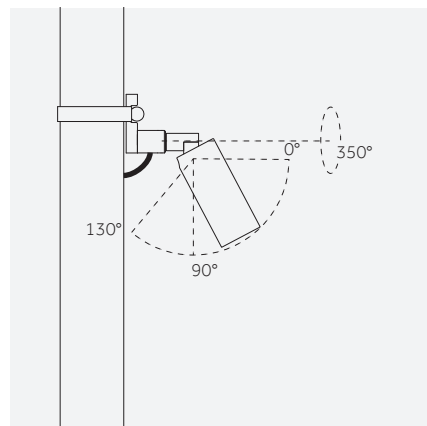
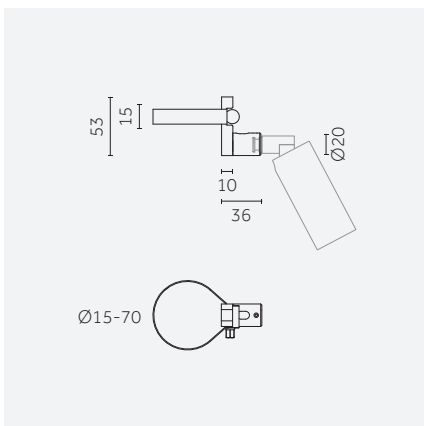

EN Tube clamp
IT Clamp per tubi

EN Adjustability (0-130°) on horizontal axis and 350° on vertical axis
IT Orientabilità (0-130°) su asse orizzontale e 350° su asse verticale

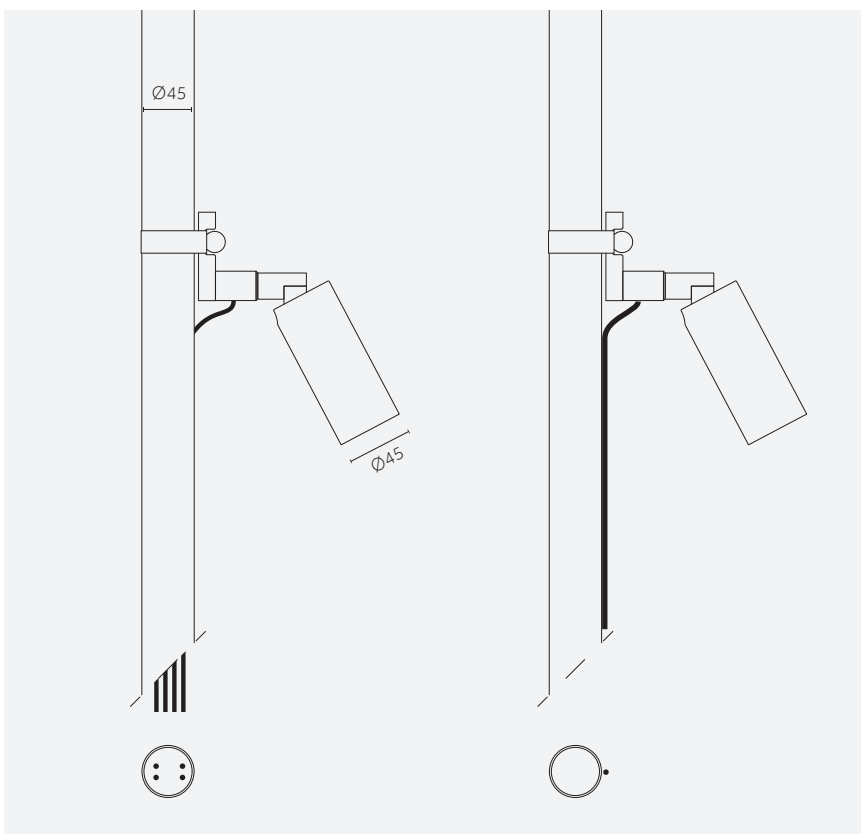

EN Create your cluster by tube clamps.
IT Crea il tuo cluster usando una serie di clamp.

Availability: Q3 - 2022

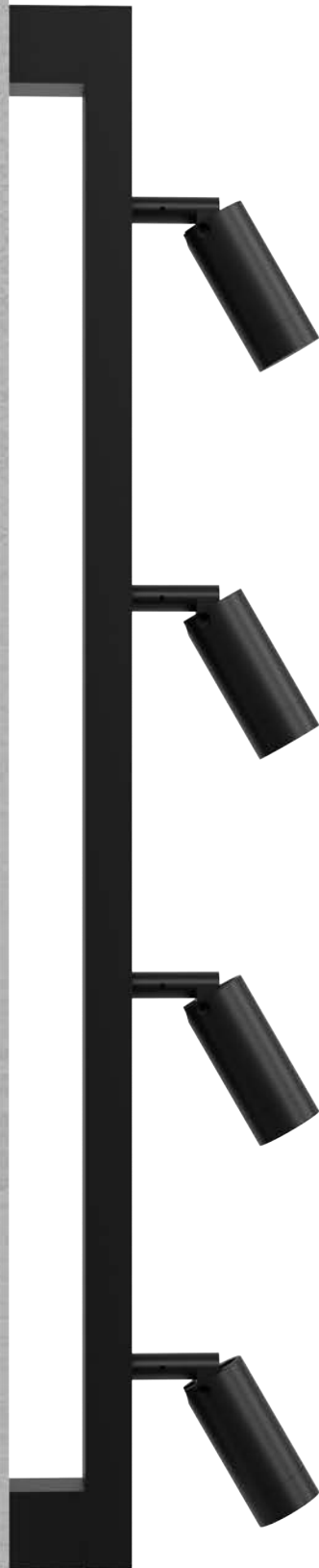

- **8D** Black anodized/
Anodizzato nero
- **9P** Corten/
Corten
- **8F** Antiqued bronze (solid brass)/
Bronzo anticato (ottone massiccio)

EN The cluster bar, available in aluminium, corten and solid brass, allows a practical and elegant fixing of 4 projectors. Designed for a "clean" integration of the rear wiring, it is the ideal solution for installations on historic buildings or to highlight details of contemporary architecture.

IT La barra per cluster, disponibile in alluminio, corten e in ottone pieno, permette un fissaggio pratico ed elegante di 4 proiettori. Studiata per una integrazione "pulita" dei cablaggi posteriori, è la soluzione ideale per installazioni su edifici storici o dettagli di architettura contemporanea.

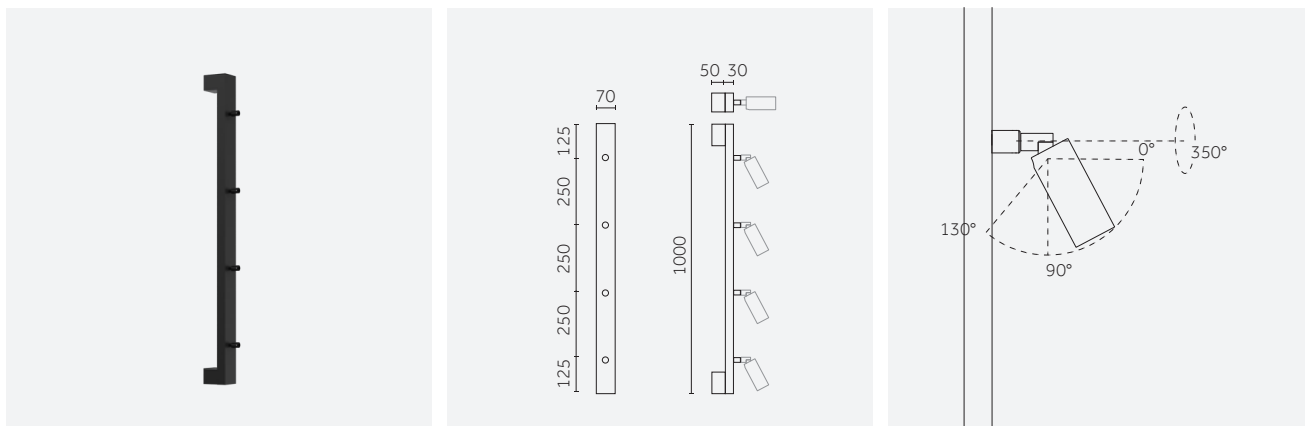

EN Cluster bar (custom length on request)

IT Barra per cluster (lunghezza custom su richiesta)

EN Adjustability (0-130°) on horizontal axis and 350° on vertical axis

IT Orientabilità (0-130°) su asse orizzontale e 350° su asse verticale



A quality light

^{EN} LED with CRI>90 making the whole range suitable for high-end applications. (CRI>80 on request for very high efficacy solutions).

^{IT} LED con CRI>90 disponibile per tutto il sistema, per garantire luce di qualità. (CRI>80 on request for very high efficacy solutions).

^{EN} Dark sky "compliant". No spillage of light above horizontal axis when the projector head is parallel to floor level. Very narrow beam allows for maximum glare control.

^{IT} Dark sky "compliant". Nessuna dispersione di luce sopra l'asse orizzontale quando la testa del proiettore è parallela al livello del pavimento. Il fascio molto stretto permette un controllo massimo dell'abbagliamento.



^{EN} Optic is positioned further back from external protective glass to allow maximum glare control regardless of the use of any accessory.

^{IT} L'ottica arretrata rispetto al vetro di protezione esterno consente alto controllo dell'abbaglio anche senza alcun accessorio.

EN Precision lenses offer quality distribution of light and smooth edge beams in line with the standard Yori optics. The wide range of color temperatures with CRI >90 ensure high quality light and consistency between internal and outdoor spaces.

IT Le lenti ad alta precisione offrono una distribuzione di qualità della luce e fasci puliti, in linea con le tipiche ottiche Yori. L'ampia gamma di temperature di colore con CRI >90 garantisce luce di alta qualità e coerenza tra spazi interni ed esterni.

EN Optics
IT Ottiche

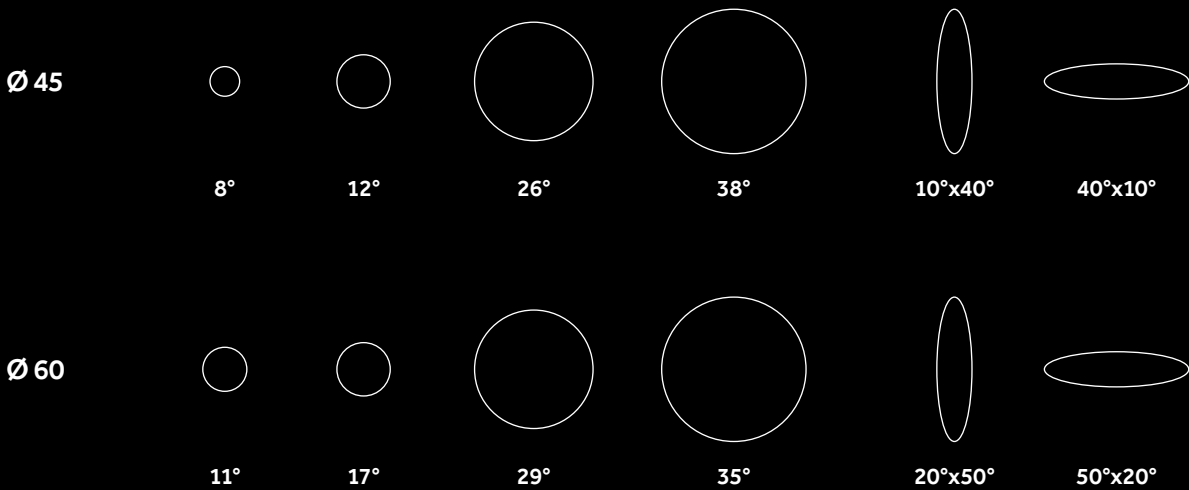

EN Coloured temperature
IT Temperatura colore

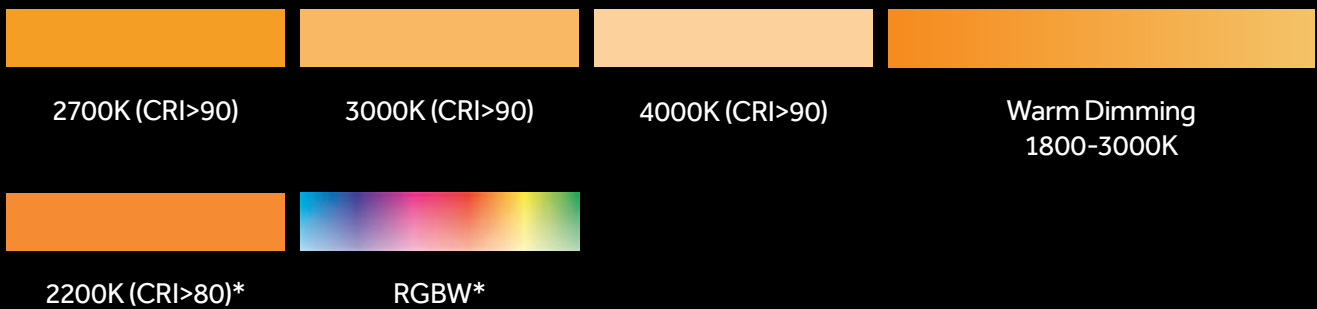

*On request / su richiesta

^{EN} Yori IP66 is also available with different integrated accessories: selective filters to modify the color temperature of the LED to colored filters for optional light effects. Spread lens, honeycomb and anti-glare screens complete the range.

^{IT} Yori IP66 è disponibile anche con differenti accessori integrati: dai filtri selettivi per variare la temperatura colore del LED ai filtri colorati per opzionali effetti di luce. Lente diffondente, schermi alveolari e antiglare completano la gamma.

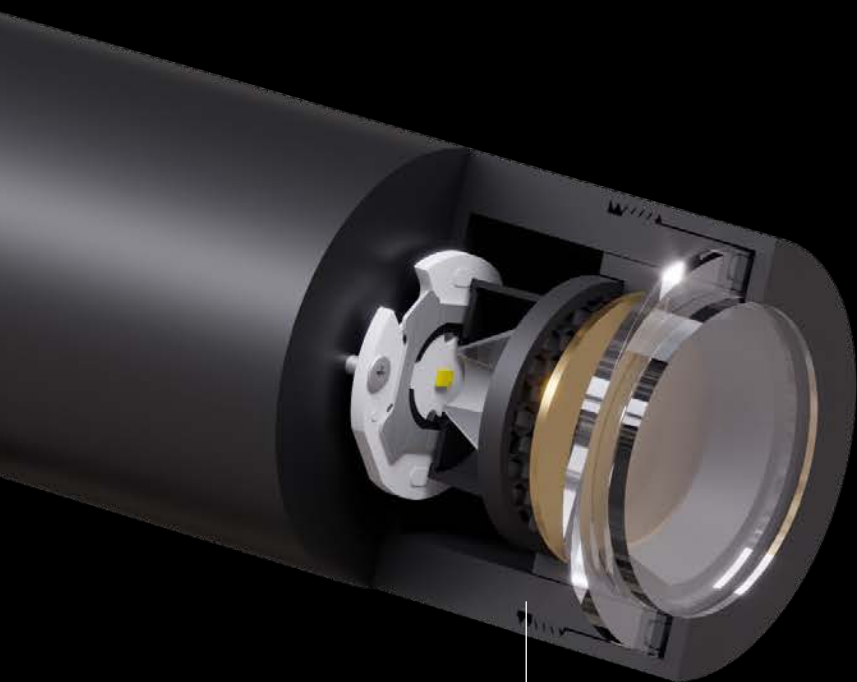

^{EN} Coloured filters
^{IT} Filtri colorati

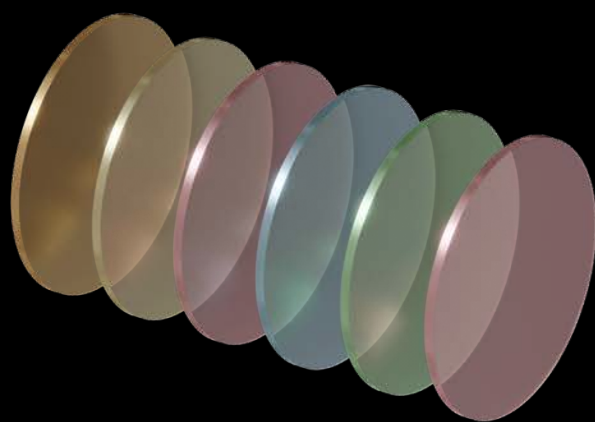

^{EN} Possibility to order Yori IP66 with two internal accessories.

^{IT} Possibilità di ordinare Yori IP66 con due accessori interni.

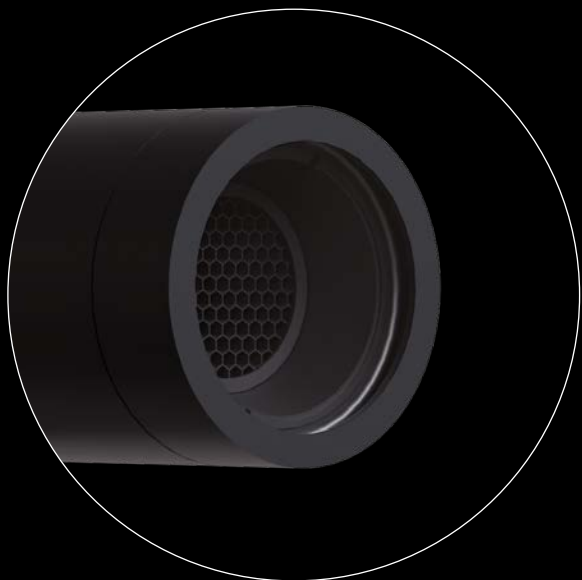

^{EN} The accessories are pre-mounted at the factory, see p. 50 to discover how to order your Yori IP66 with accessories.

^{IT} Gli accessori sono pre-montanti in fabbrica, vedi p. 50 per scoprire come ordinare il tuo Yori IP66 con accessori.

^{EN} Selective filters
^{IT} Filtri selettivi

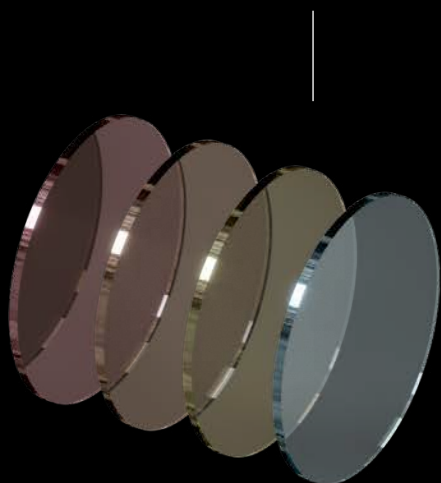

^{EN} Honeycomb and spread lens
^{IT} Griglia alveolare e lente diffondente

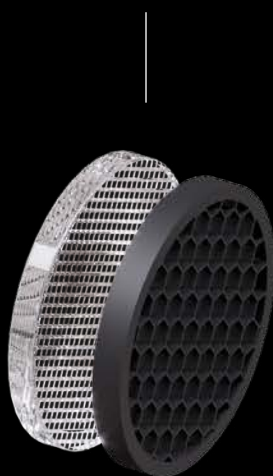

^{EN} Antiglare
^{IT} Antiglare



Ø 45 mm

Risk 1 0.36 (8F) 0.99 IP66 IK07 850° CE EAC UK

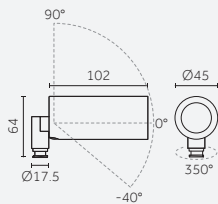

Code example:

X . BR00 A . HW 8C

Finishes: p. 89-91
 Electrical devices: p. 52-55
 Photometric data:
 www.reggiani.net

Notes:
 *Special finishes/
 Finiture speciali

2 W POWERLED		Lumen delivered up to 187 lm / Lumen maintenance: L80 B10=50,000 h						
Driver	Version	Optics	LED	K	CRI	lm	SDCM	Finishes
X Not included	BR00	A 8° Very narrow	HW	2700	>90	178	<3	8C
Constant voltage (Vdc)		B 12° Narrow	HQ	3000	>90	188	<3	8D
		E 26° Medium	HN	4000	>90	202	<3	8F
		H 38° Wide	LED nominal lumen					8E*
		M 10°x40° Elliptical						9D*
		N 40°x10° Elliptical						9F*
								9M*
								9N*
								9P*
								9Q*

3,2 W POWERLED		Lumen delivered up to 261 lm / Lumen maintenance: L80 B10=50,000 h						
Driver	Version	Optics	LED	K	CRI	lm	SDCM	Finishes
X Not included	BR01	A 8° Very narrow	HW	2700	>90	249	<3	8C
Constant voltage (Vdc)		B 12° Narrow	HQ	3000	>90	263	<3	8D
		E 26° Medium	HN	4000	>90	283	<3	8F
		H 38° Wide	LED nominal lumen					8E*
		M 10°x40° Elliptical						9D*
		N 40°x10° Elliptical						9F*
								9M*
								9N*
								9P*
								9Q*

Ø 60 mm

Risk 1 0.57 (8F) 1.68 IP66 IK07 850° CE EAC UK

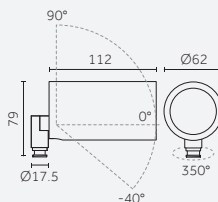

Code example:

X . CR01 A . HW 8C

Finishes: p. 89-91
 Electrical devices: p. 52-55
 Photometric data:
 www.reggiani.net

Notes:
 *Special finishes/
 *Finiture speciali

4,5 W POWERLED		Lumen delivered up to 441 lm / Lumen maintenance: L80 B10=50,000 h						
Driver	Version	Optics	LED	K	CRI	lm	SDCM	Finishes
X Not included	CR01	A 11° Very narrow	HW	2700	>90	605	<3	8C
Constant voltage (Vdc)		B 17° Narrow	HQ	3000	>90	647	<3	8D
		E 29° Medium	HN	4000	>90	697	<3	8F
		H 35° Wide	LED nominal lumen					8E*
		M 20°x50° Elliptical						9D*
		N 50°x20° Elliptical						9F*
								9M*
								9N*
								9P*
								9Q*

7 W POWERLED		Lumen delivered up to 611 lm / Lumen maintenance: L80 B10=50,000 h						
Driver	Version	Optics	LED	K	CRI	lm	SDCM	Finishes
X Not included	CR02	A 11° Very narrow	HW	2700	>90	837	<3	8C
Constant voltage (Vdc)		B 17° Narrow	HQ	3000	>90	896	<3	8D
		E 29° Medium	HN	4000	>90	966	<3	8F
		H 35° Wide	LED nominal lumen					8E*
		M 20°x50° Elliptical						9D*
		N 50°x20° Elliptical						9F*
								9M*
								9N*
								9P*
								9Q*

12 W POWER LED		Lumen delivered up to 916 lm / Lumen maintenance: L80 B10=50,000 h						Finishes	
Driver	Version	Optics	LED	K	CRI	lm	SDCM		
X Not included	CR03	A 11° Very narrow	HW	2700	>90	1256	<3	8C	
Constant voltage (Vdc)		B 17° Narrow	HQ	3000	>90	1345	<3	8D	
		E 29° Medium	HN	4000	>90	1449	<3	8F	
		H 35° Wide	LED nominal lumen					8E*	
		M 20°x50° Elliptical						9D*	
		N 50°x20° Elliptical						9F*	
							9M*		
							9N*		
							9P*		
							9Q*		

11,8 W Warm Dimming COB LED		Lumen delivered up to 545 lm / Lumen maintenance: L70 B10=50,000 h						Finishes	
Driver	Version	Optics	LED	K	CRI	lm	SDCM		
X Not included	CR0D	B 17° Narrow	DT	1800-3000	>90	35-1246	<4	8C	
Constant current (mA)		H 38° Wide	LED nominal lumen					8D	
								8F	
								8E*	
								9D*	
								9F*	
								9M*	
								9N*	
								9P*	
								9Q*	

Ø 45 mm | Accessories

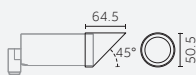

Description
 Ø 45 mm Snoot 45°/
 Ø 45 mm Snoot 45°

Code
 0.27404.00

Finishes
 8D
 8F

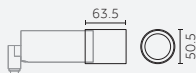

Description
 Ø 45 mm Snoot/
 Ø 45 mm Snoot

Code
 0.27405.00

Finishes
 8D
 8F

Ø 60 mm | Accessories

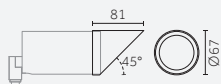

Description
 Ø 60 mm Snoot 45°/
 Ø 60 mm Snoot 45°

Code
 0.27406.00

Finishes
 8D
 8F

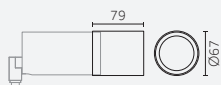

Description
 Ø 60 mm Snoot/
 Ø 60 mm Snoot

Code
 0.27407.00

Finishes
 8D
 8F

Ø 45 mm | Ø 60 mm | Accessories

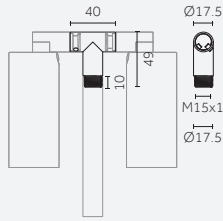
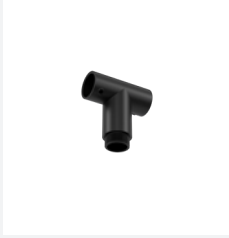

Description
Double head for spike/
Testa doppia per picchetto

Code
0.27402.00

Finishes
8D
8F

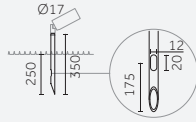

Description
Spike 350 mm/
Picchetto 350 mm

Code
0.27411.00

Finishes
8D
8F

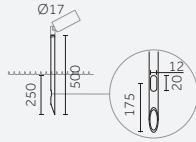

Description
Spike 500 mm/
Picchetto 500 mm

Code
0.27412.00

Finishes
8D
8F

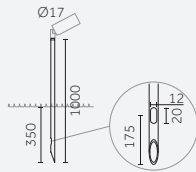

Description
Spike 1000 mm/
Picchetto 1000 mm

Code
0.27413.00

Finishes
8D
8F



Description
Pole 350 mm/
Tubolare 350 mm

Code
0.27420.00

Finishes
8D
8F



Description
Pole 500 mm/
Tubolare 500 mm

Code
0.27421.00

Finishes
8D
8F

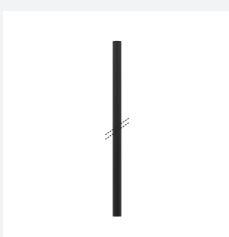

Description
Pole 1000 mm/
Tubolare 1000 mm

Code
0.27422.00

Finishes
8D
8F



Description
Antirotation spike/
Antirotazione

Code
0.27414.0000

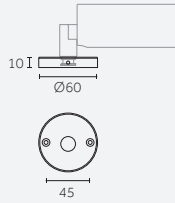

Description
Base/
Base
*Special finishes/
Finiture speciali

Code
0.27410.00

Finishes

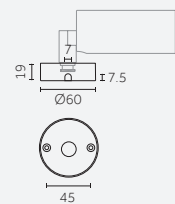
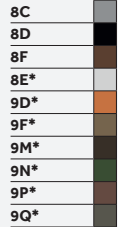

Description
Base with side cable entry/
Base con entrata cavo laterale
*Special finishes/
Finiture speciali

Code
0.27415.00

Finishes

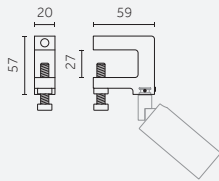
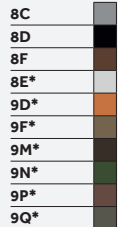

Description
Beam clamp/
Clamp per travi

Code
0.27403.00

Finishes

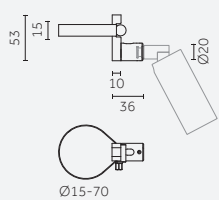
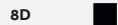

Description
Tube clamp/
Clamp per tubi

Code
0.27401.00

Finishes

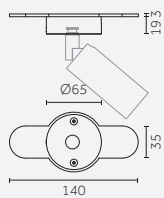
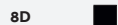

Description
Tree strap/
Fascia per rami

Code
0.27417.00

Finishes

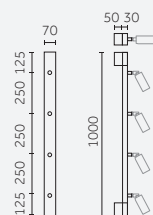
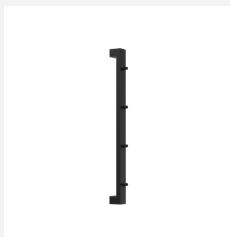
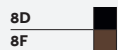

Description
Metal bar for cluster fixing (4X)/
Barra metallica per fissaggio in cluster (4X)
*Special finish/
Finitura speciale

Code
0.27418.00

Finishes



Internal accessories

EN Internal accessories are pre-mounted at the factory.

To specify Yori IP66 with an internal accessory:

- choose your product;
- choose one internal accessory;
- add the accessory code to the end of the product code.

IT Gli accessori interni sono integrati nel prodotto.

Per ordinare Yori IP66 con un accessorio interno:

- scegli il tuo prodotto;
- scegli un accessorio interno;
- aggiungi il codice accessorio alla fine del codice prodotto.



Examples:

Product code:
X.BR00A.HW8D
X.BR00A.HW8D

Accessory code:
.9A (Colored glass filter orange)
.S (Spread lens)

Product with accessory:
X.BR00A.HW8D.**9A**
X.BR00A.HW8D.**S**

EN To order two accessories select:

- one colored or selective filter (ie .9A);
- one honeycomb and accessories (ie .S);
- add the two codes to the end of the product code.

IT Per ordinare due accessori selezionare:

- un filtro colorato o selettivo (es. .9A);
- una griglia alveolare e accessori (es. .H);
- aggiungere i due codici alla fine del codice prodotto.



Example:

Product code:
X.BR00A.HW8D
(Yori IP66)

Accessory 1:
.9A
(Colored glass filter orange)

Accessory 2:
H
(Honeycomb)

Product with 2 accessories:
X.BR00A.HW8D.**9AH**

Ø 45 mm | Ø 60 mm | Internal accessories

Colored and selective filters/ Filtri colorati e selettivi



Description	Code
Colored glass filter red/ Filtro colorato rosso	<u>.4A</u>



Colored glass filter green/ Filtro colorato verde	<u>.5A</u>
--	------------



Colored glass filter blue/ Filtro colorato blu	<u>.6A</u>
---	------------



Description	Code
Colored glass filter pink/ Filtro colorato rosa	<u>.7A</u>



Colored glass filter yellow/ Filtro colorato giallo	<u>.8A</u>
--	------------



Colored glass filter orange/ Filtro colorato arancio	<u>.9A</u>
---	------------



Description	Code
Selective filter 2700-2000 K/ Filtro selettivo 2700-2000 K	<u>.20K</u>



Selective filter 2700-2200 K/ Filtro selettivo 2700-2200 K	<u>.22K</u>
---	-------------



Description	Code
Selective filter 2700-2500 K/ Filtro selettivo 2700-2500 K	<u>.25K</u>



Selective filter 3000-3500 K/ Filtro selettivo 3000-3500 K	<u>.35K</u>
---	-------------

Lens and accessories/ Lenti e accessori



Description	Code
Spread lens/ Lente diffondente	<u>.S</u>



Description	Code
Honeycomb/ Griglia alveolare	<u>.H</u>



Honeycomb + softener/ Griglia alveolare + filtro	<u>.L</u>
---	-----------





Description	Code
Antiglare/ Antiglare	<u>.A</u>
Available only for Ø60mm/ Disponibile solo per Ø60mm	

Electrical devices



Ø45 mm | Electrical devices

Driver/ Alimentazioni

2 W POWER LED (2,7 W total product consumption)



Type	Code	Watt	Size (mm)	IP	Tech. specification / Input	Output	Connectable fixtures	Cable length max	Cable section
On/Off	0.30524.0000	12 W		20	220-240 Vac / 50/60 Hz	24 Vdc	Max: 4	See table: p. 55	See table: p. 55
On/Off	0.30525.0000	70 W		67	220-240 Vac / 50/60 Hz	24 Vdc	Max: 23	See table: p. 55	See table: p. 55
On/Off	0.30526.0000	150 W		67	220-240 Vac / 50/60 Hz	24 Vdc	Max: 50	See table: p. 55	See table: p. 55

3,2 W POWER LED (4,5 W total product consumption)



Type	Code	Watt	Size (mm)	IP	Tech. specification / Input	Output	Connectable fixtures	Cable length max	Cable section
On/Off	0.30524.0000	12 W		20	220-240 Vac / 50/60 Hz	24 Vdc	Max: 2	See table: p. 55	See table: p. 55
On/Off	0.30525.0000	70 W		67	220-240 Vac / 50/60 Hz	24 Vdc	Max: 14	See table: p. 55	See table: p. 55
On/Off	0.30526.0000	150 W		67	220-240 Vac / 50/60 Hz	24 Vdc	Max: 30	See table: p. 55	See table: p. 55

Dimmer/ Dimmer

2 W POWER LED (2,7 W total product consumption)

Type	Code	Watt	Size (mm)	IP	Tech. specification / Input	Output	Connectable fixtures	Cable length max	Cable section
DALI Dimm 1-10V Push	Y.30826.0000	150 W		20	24 Vdc	24 Vdc	Max: 50	See table: p. 55	See table: p. 55
DALI	D.30850.0000	150 W		67	24 Vdc	24 Vdc	Max: 50	See table: p. 55	See table: p. 55
DMX	DX.30851.0000	150 W		20	24 Vdc	24 Vdc	Max: 50	See table: p. 55	See table: p. 55



3,2 W POWER LED (4,5 W total product consumption)

Type	Code	Watt	Size (mm)	IP	Tech. specification / Input	Output	Connectable fixtures	Cable length max	Cable section
DALI Dimm 1-10V Push	Y.30826.0000	150 W		20	24 Vdc	24 Vdc	Max: 30	See table: p. 55	See table: p. 55
DALI	D.30850.0000	150 W		67	24 Vdc	24 Vdc	Max: 30	See table: p. 55	See table: p. 55
DMX	DX.30851.0000	150 W		20	24 Vdc	24 Vdc	Max: 30	See table: p. 55	See table: p. 55



Ø60 mm | Electrical devices

Driver/ Alimentazioni



4,5 W POWER LED (5,5 W total product consumption)

Type	Code	Watt	Size (mm)	IP	Tech. specification / Input	Output	Connectable fixtures	Cable length max	Cable section
On/Off	0.30524.0000	12 W		20	220-240 Vac / 50/60 Hz	24 Vdc	Max: 2	See table: p. 55	See table: p. 55
On/Off	0.30525.0000	70 W		67	220-240 Vac / 50/60 Hz	24 Vdc	Max: 11	See table: p. 55	See table: p. 55
On/Off	0.30526.0000	150 W		67	220-240 Vac / 50/60 Hz	24 Vdc	Max: 24	See table: p. 55	See table: p. 55

7 W POWER LED (8 W total product consumption)

Type	Code	Watt	Size (mm)	IP	Tech. specification / Input	Output	Connectable fixtures	Cable length max	Cable section
On/Off	0.30524.0000	12 W		20	220-240 Vac / 50/60 Hz	24 Vdc	Max: 1	See table: p. 55	See table: p. 55
On/Off	0.30525.0000	70 W		67	220-240 Vac / 50/60 Hz	24 Vdc	Max: 7	See table: p. 55	See table: p. 55
On/Off	0.30526.0000	150 W		67	220-240 Vac / 50/60 Hz	24 Vdc	Max: 16	See table: p. 55	See table: p. 55

12 W POWER LED (13 W total product consumption)



Type	Code	Watt	Size (mm)	IP	Tech. specification / Input	Output	Connectable fixtures	Cable length max	Cable section
On/Off	0.30524.0000	12 W		20	220-240 Vac / 50/60 Hz	24 Vdc	Max: 1	See table: p. 55	See table: p. 55
On/Off	0.30525.0000	70 W		67	220-240 Vac / 50/60 Hz	24 Vdc	Max: 5	See table: p. 55	See table: p. 55
On/Off	0.30526.0000	150 W		67	220-240 Vac / 50/60 Hz	24 Vdc	Max: 12	See table: p. 55	See table: p. 55

11,8 W Warm Dimming COB LED



Type	Code	Watt	Size (mm)	IP	Tech. specification / Input	Output	Connectable fixtures	Cable length max	Cable section
DALI	D.30527.0000	15 W		68	110-240V / 50/60 Hz	350 mA	Max: 1	See table: p. 55	See table: p. 55

Dimmer/ Dimmer



4,5 W POWER LED (5,5 W total product consumption)

Type	Code	Watt	Size (mm)	IP	Tech. specification / Input	Output	Connectable fixtures	Cable length max	Cable section
DALI Dimm 1-10V Push	Y.30826.0000	150 W		20	24 Vdc	24 Vdc	Max: 24	See table: p. 55	See table: p. 55
DALI	D.30850.0000	150 W		67	24 Vdc	24 Vdc	Max: 24	See table: p. 55	See table: p. 55
DMX	DX.30851.0000	150 W		20	24 Vdc	24 Vdc	Max: 24	See table: p. 55	See table: p. 55

7 W POWER LED (8 W total product consumption)

Type	Code	Watt	Size (mm)	IP	Tech. specification / Input	Output	Connectable fixtures	Cable length max	Cable section
DALI Dimm 1-10V Push	Y.30826.0000	150 W		20	24 Vdc	24 Vdc	Max: 16	See table: p. 55	See table: p. 55
DALI	D.30850.0000	150 W		67	24 Vdc	24 Vdc	Max: 16	See table: p. 55	See table: p. 55
DMX	DX.30851.0000	150 W		20	24 Vdc	24 Vdc	Max: 16	See table: p. 55	See table: p. 55

12 W POWER LED (13 W total product consumption)

Type	Code	Watt	Size (mm)	IP	Tech. specification / Input	Output	Connectable fixtures	Cable length max	Cable section
DALI Dimm 1-10V Push	Y.30826.0000	150 W		20	24 Vdc	24 Vdc	Max: 12	See table: p. 55	See table: p. 55
DALI	D.30850.0000	150 W		67	24 Vdc	24 Vdc	Max: 12	See table: p. 55	See table: p. 55
DMX	DX.30851.0000	150 W		20	24 Vdc	24 Vdc	Max: 12	See table: p. 55	See table: p. 55

Ø 45 mm | Ø 60 mm | Cables and connectors

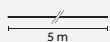
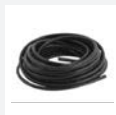

Description
Cable 0,5 mmq 5 m/
Cavo 0,5 mmq 5 m

Code
0.27450.0000

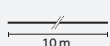

Description
Cable 0,5 mmq 10 m/
Cavo 0,5 mmq 10 m

Code
0.27451.0000

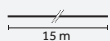

Description
Cable 0,5 mmq 15 m/
Cavo 0,5 mmq 15 m

Code
0.27452.0000

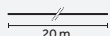

Description
Cable 0,5 mmq 20 m/
Cavo 0,5 mmq 20 m

Code
0.27453.0000

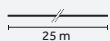

Description
Cable 0,5 mmq 25 m/
Cavo 0,5 mmq 25 m

Code
0.27454.0000

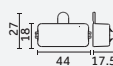

Description
Cable connector 0,5 mmq (2 way)/
Connettore per cavo 0,5 mmq (2 vie)

Code
0.27440.0000

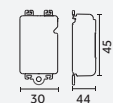

Description
Cable connector 0,5 mmq (3 way) T/
Connettore per cavo 0,5 mmq (3 vie) T

Code
0.27441.0000



Description
Cable connector 2,5 mmq (2way)/
Connettore per cavo 2,5 mmq (2 vie)

Code
0.27430.0000

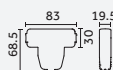

Description
Cable connector 2,5 mmq (3 way) T/
Connettore per cavo 2,5 mmq (3 vie) T

Code
0.27431.0000

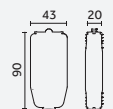

Description
Cable connector 2,5 mmq (3 way) Y/
Connettore per cavo 2,5 mmq (3 vie) Y

Code
0.27432.0000

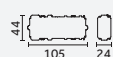

Description
Cable connector 2,5 mmq (4 way)/
Connettore per cavo 2,5 mmq (4 vie)

Code
0.27433.0000

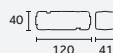

Description
Cable connector 4 mmq (2 way)/
Connettore per cavo 4 mmq (2 vie)

Code
0.27447.0000

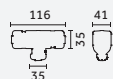

Description
Cable connector 4 mmq (3way) T/
Connettore per cavo 4 mmq (3 vie) T

Code
0.27448.0000

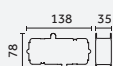

Description
Cable connector 4mmq (4 way)/
Connettore per cavo 4 mmq (4 vie)

Code
0.27449.0000

Wiring examples

Loop in loop out/
Loop in loop out/

Code Driver	Watt	Cable section	Cable length max
0.30524.0000	12 W	0,5 mmq	15 m
		1,5 mmq	35 m
		2,5 mmq	50 m
		4 mmq	100 m
0.30525.0000	70 W	0,5 mmq	5 m
		1,5 mmq	10 m
		2,5 mmq	20 m
		4 mmq	40 m
0.30526.0000	150 W	0,5 mmq	—
		1,5 mmq	5 m
		2,5 mmq	7,5 m
		4 mmq	17,5 m

Notes:

Recommended cable section in relation to the voltage drop/
Sezione del cavo consigliata in rapporto alla caduta di tensione

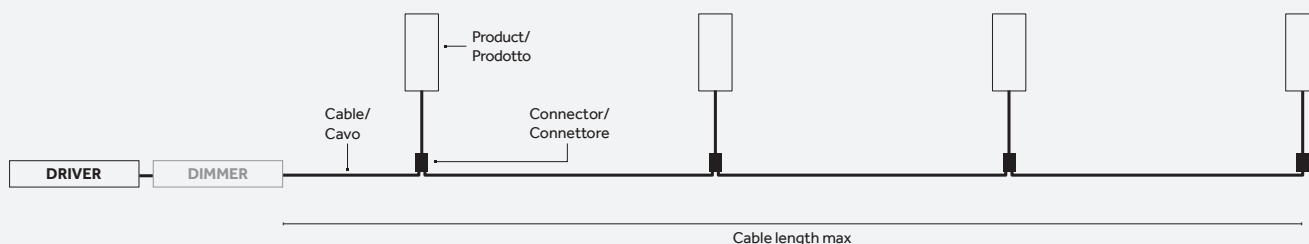

With central driver/
Con driver centrale/

Cable section	Total product consumption (Watt)						
	2,7 W	4,5 W	5,5 W	8 W	13 W	5,5 W + 5,5 W	8 W + 8 W
0,5 mmq	Max 60 m	Max 40 m	Max 30 m	Max 25 m	Max 15 m	Max 15 m	Max 10 m
1,5 mmq	Max 160 m	Max 110 m	Max 100 m	Max 70 m	Max 50 m	Max 50 m	Max 35 m
2,5 mmq	Max 500 m	Max 325 m	Max 300 m	Max 200 m	Max 125 m	Max 150 m	Max 100 m
4 mmq	Max 750 m	Max 550 m	Max 450 m	Max 325 m	Max 200 m	Max 225 m	Max 175 m

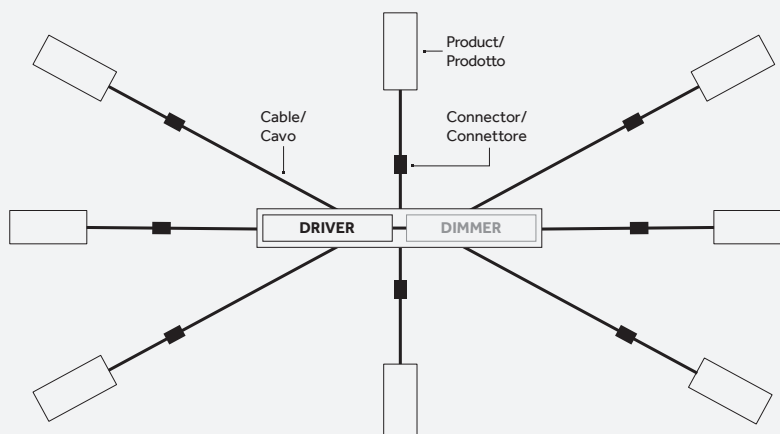

Yori IP66

Surface/Pendant



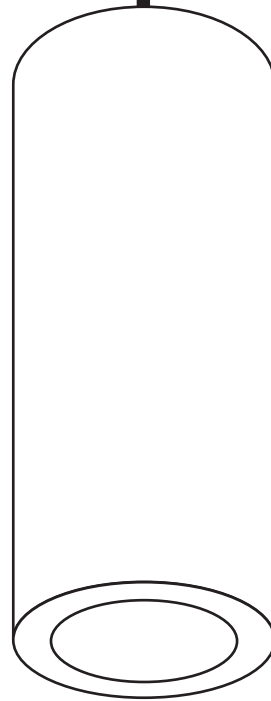
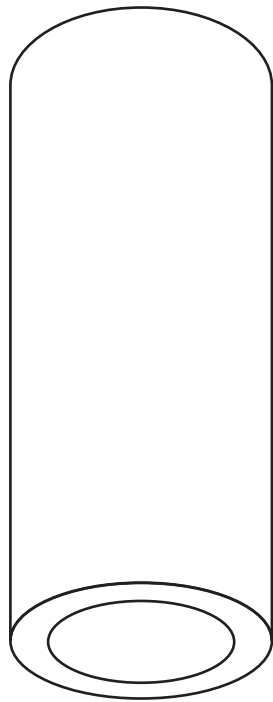



Yori IP66 Surface/Pendant





EN Yori IP66 Surface/Pendant is the outdoor version of the standard indoor Yori Surface/Pendant. With a large selection of finishes and excellent performances, it's the ideal solution for high end exterior projects. Its wide range of optics and color temperatures (CRI>90) guarantees total consistency between interior and exterior spaces.

IT Yori IP66 Surface/Pendant è la versione per esterni della gamma Yori. Con eccellenti prestazioni illuminotecniche e un'incredibile varietà di finiture è la soluzione ideale per aree esterne highend. L'ampia gamma di ottiche e temperature di colore (CRI>90) garantiscono totale coerenza tra gli ambienti (interni/esterni).



Versions/ Versioni					
Yori IP66 Surface/Pendant					
	Ø45	Ø60			
Finishes/ Finiture					
	8C Raw anodized/ Anodizzato naturale	8D Black anodized/ Anodizzato nero	8F Antiqued bronze (solid brass)/ Bronzo anticato (ottone massiccio)		
Special finishes/ Finiture speciali					
	8E Stainless steel (AISI 316)/ Acciaio inox (AISI 316)	9D Copper/ Rame	9F Champagne anodized/ Anodizzato champagne	9M Antiqued bronze/ Bronzo anticato	
					
	9N Olive green/ Verde oliva	9P Corten/ Corten	9Q Titanium/ Titanio		
	If not specified, the product is made of aluminium/ Se non specificato, il prodotto è in alluminio				
IP / IK	66 / 07				
Control systems	On/Off; DALI; 1-10V; PUSH; DMX				
Insulation class	⚡				
Certifications	CE EAC UK				



	Ø 45 mm	Ø 60 mm
<p>Yori IP66 Surface / Pendant</p>  	p.66	p.66
	8°; 12°; 26°; 38°; 10°x40°	11°; 17°; 29°; 35°; 20°x50°
<p>Light source/ Sorgente luminosa</p>	<p>POWER LED 2 W; 3,2 W 178 lm - 283 lm L80 B10=50,000h 2700 K; 3000 K; 4000 K SDCM <3 CRI >90</p>	<p>POWER LED 4,5 W; 7 W; 12 W 605 lm - 1449 lm L80 B10=50,000h 2700 K; 3000 K; 4000 K SDCM <3 CRI >90</p> <p>Warm Dimming COB LED 11,8 W 35 lm - 1246 lm L70 B10=50,000h 1800 K - 3000 K SDCM <4 CRI >90</p>

Make it pendant



EN Transform Yori Surface in a suspension thanks to the pendant accessories. Available for both versions, Ø45 and Ø60mm in all finishes. *Stainless steel and solid brass versions (Ø60) feature a support cable to ensure full stability.

IT Trasforma Yori Surface in una sospensione grazie agli appositi accessori di pendinamento, disponibili sia per la versione Ø45 che Ø60 e nell'intera gamma di finiture. *Le versioni in acciaio inox e ottone massiccio (Ø60) presentano un cavo di supporto in acciaio per garantire totale stabilità.

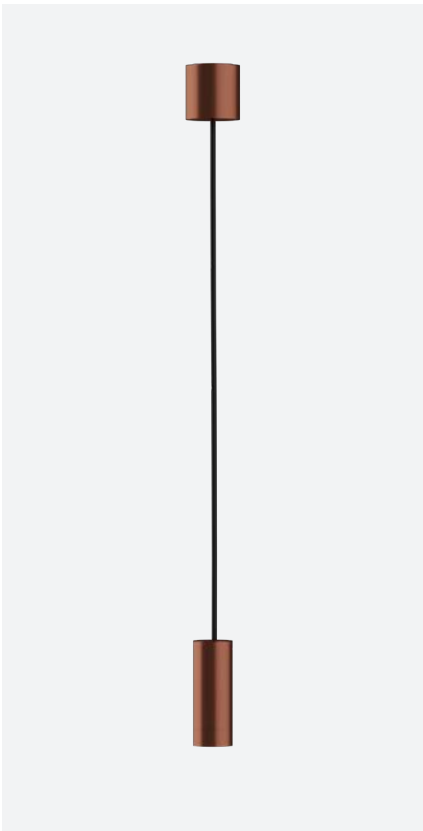

EN Yori Surface Ø45 with pendant accessory
IT Yori Surface Ø45 con accessorio pendant

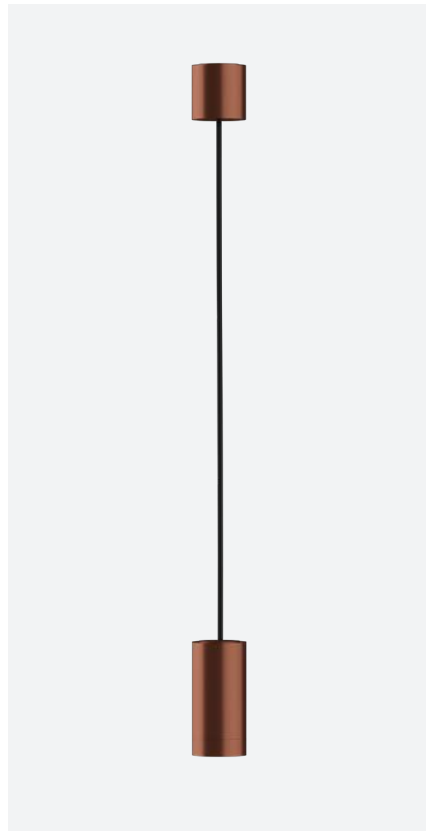

EN Yori Surface Ø60 with pendant accessory
IT Yori Surface Ø60 con accessorio pendant

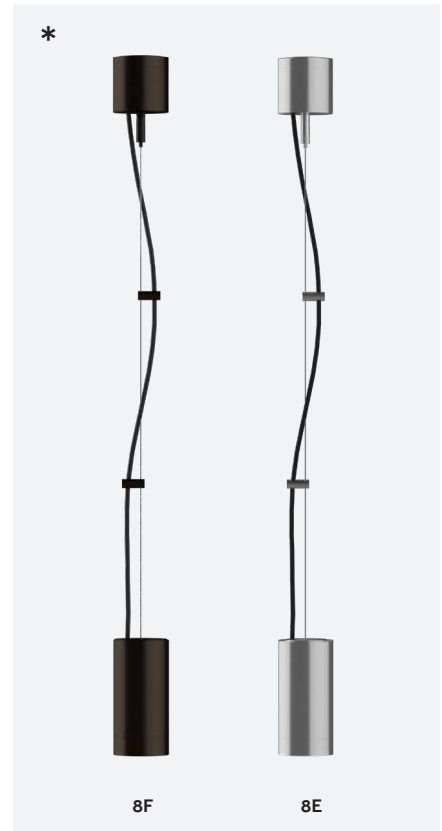

EN Pendant base with support steel cable
IT Rosone con cavo metallico di sostegno

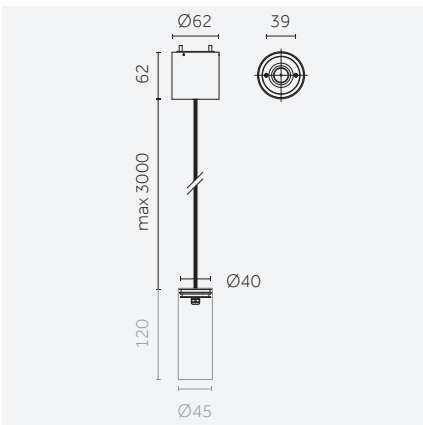

EN Pendant base standard
IT Rosone standard

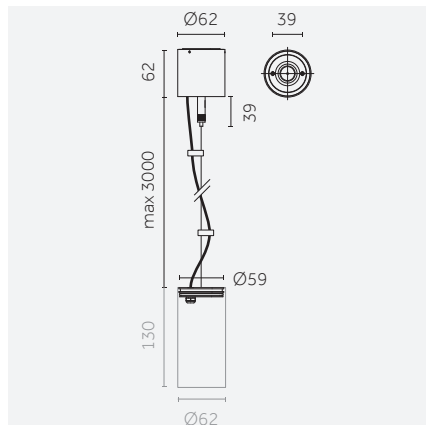

EN Pendant base with support steel cable
IT Rosone con cavo metallico di sostegno



EN Dettaglio su attacco cavo di sostegno
IT Detail on the steel cable connection

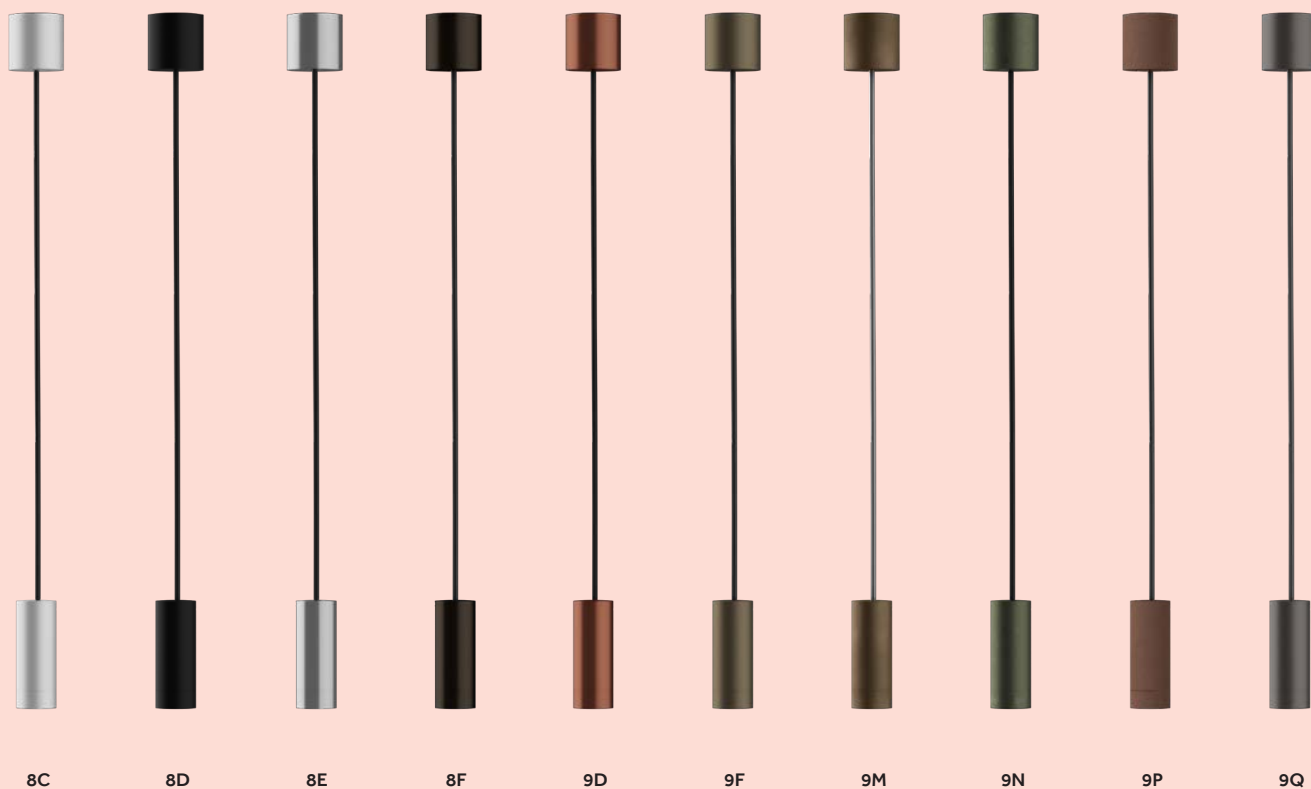

8C 8D 8E 8F 8D 9F 9M 9N 9P 9Q

- 8C** Raw anodized/
Anodizzato naturale
- 8D** Black anodized/
Anodizzato nero
- 8E** Stainless steel (AISI 316)/
Acciaio inox (AISI 316)
- 8F** Antiqued bronze (solid brass)/
Bronzo anticato (ottone massiccio)
- 9D** Copper/
Rame
- 9F** Champagne anodized/
Anodizzato champagne
- 9M** Antiqued bronze/
Bronzo anticato
- 9N** Olive green/
Verde oliva
- 9P** Corten/
Corten
- 9Q** Titanium/
Titanio

^{EN} If not specified, accessories are made of aluminium
^{IT} Se non specificato, gli accessori sono in alluminio

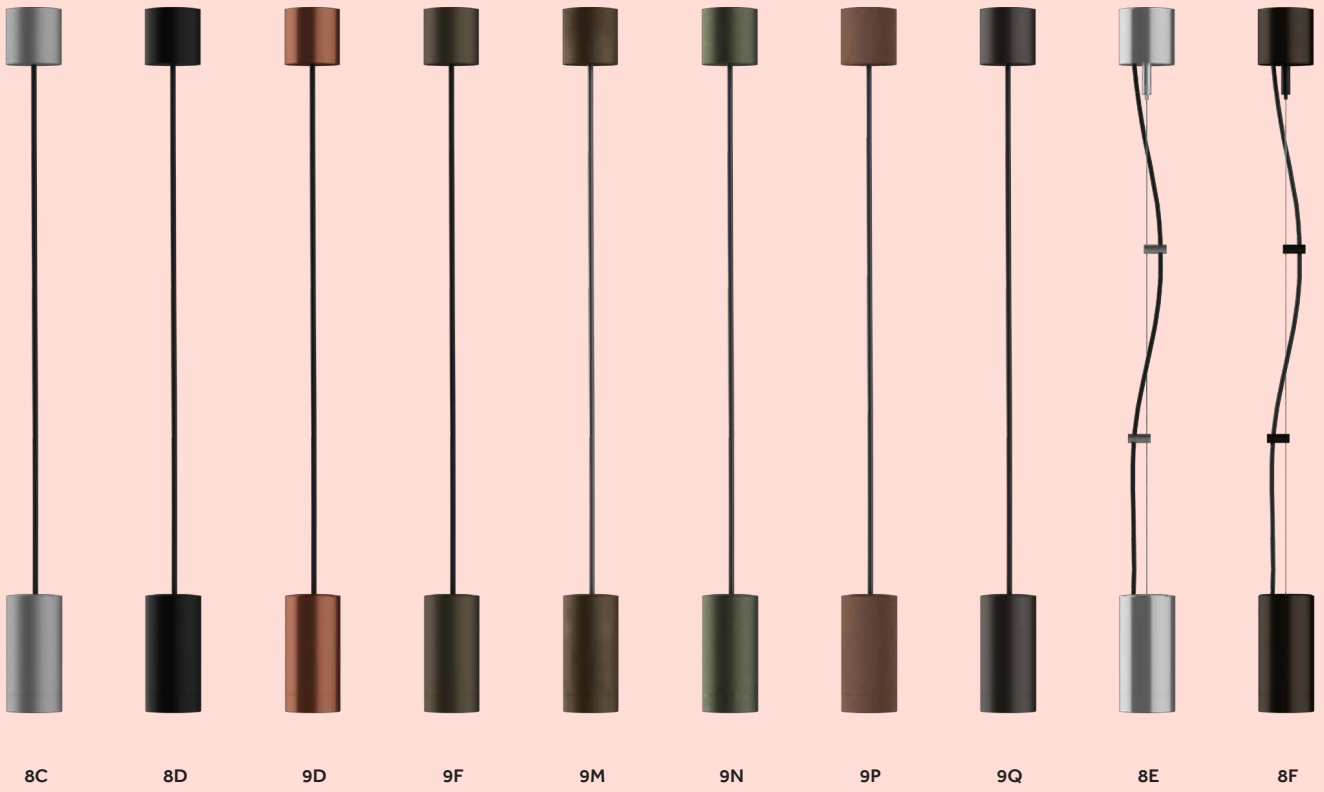

Ø 45 mm

Risk 1 0.42 (8F) 1.18 IP66 IK07 850° CE EAC UK



Code example:

X . GR00 A . HW 8C

Finishes: p. 89-91

Electrical devices: p. 70-73

Photometric data:

www.reggiani.net

Notes:

*Special finishes/
Finiture speciali

2 W POWERLED		Lumen delivered up to 187 lm / Lumen maintenance: L80 B10=50,000 h						
Driver	Version	Optics	LED	K	CRI	lm	SDCM	Finishes
X Not included	GR00	A 8° Very narrow	HW	2700	>90	178	<3	8C
Constant voltage (Vdc)		B 12° Narrow	HQ	3000	>90	188	<3	8D
		E 26° Medium	HN	4000	>90	202	<3	8F
		H 38° Wide	LED nominal lumen				8E*	
		M 10°x40° Elliptical					9D*	
							9F*	
							9M*	
							9N*	
							9P*	
							9Q*	

3,2 W POWERLED		Lumen delivered up to 261 lm / Lumen maintenance: L80 B10=50,000 h						
Driver	Version	Optics	LED	K	CRI	lm	SDCM	Finishes
X Not included	GR01	A 8° Very narrow	HW	2700	>90	249	<3	8C
Constant voltage (Vdc)		B 12° Narrow	HQ	3000	>90	263	<3	8D
		E 26° Medium	HN	4000	>90	283	<3	8F
		H 38° Wide	LED nominal lumen				8E*	
		M 10°x40° Elliptical					9D*	
							9F*	
							9M*	
							9N*	
							9P*	
							9Q*	

Ø 60 mm

Risk 1 0.63 (8F) 1.77 IP66 IK07 850° CE EAC UK



Code example:

X . FR01 A . HW 8C

Finishes: p. 89-91

Electrical devices: p. 70-73

Photometric data:

www.reggiani.net

Notes:

*Special finishes/
Finiture speciali

4,5 W POWERLED		Lumen delivered up to 441 lm / Lumen maintenance: L80 B10=50,000 h						
Driver	Version	Optics	LED	K	CRI	lm	SDCM	Finishes
X Not included	FR01	A 11° Very narrow	HW	2700	>90	605	<3	8C
Constant voltage (Vdc)		B 17° Narrow	HQ	3000	>90	647	<3	8D
		E 29° Medium	HN	4000	>90	697	<3	8F
		H 35° Wide	LED nominal lumen				8E*	
		M 20°x50° Elliptical					9D*	
							9F*	
							9M*	
							9N*	
							9P*	
							9Q*	

7 W POWERLED		Lumen delivered up to 611 lm / Lumen maintenance: L80 B10=50,000 h						
Driver	Version	Optics	LED	K	CRI	lm	SDCM	Finishes
X Not included	FR02	A 11° Very narrow	HW	2700	>90	837	<3	8C
Constant voltage (Vdc)		B 17° Narrow	HQ	3000	>90	896	<3	8D
		E 29° Medium	HN	4000	>90	966	<3	8F
		H 35° Wide	LED nominal lumen				8E*	
		M 20°x50° Elliptical					9D*	
							9F*	
							9M*	
							9N*	
							9P*	
							9Q*	

12 W POWER LED		Lumen delivered up to 916 lm / Lumen maintenance: L80 B10=50,000 h						Finishes
Driver	Version	Optics	LED	K	CRI	lm	SDCM	Finishes
X Not included	FR03	A 11° Very narrow	HW	2700	>90	1256	<3	8C
Constant voltage (Vdc)		B 17° Narrow	HQ	3000	>90	1345	<3	8D
		E 29° Medium	HN	4000	>90	1449	<3	8F
		H 35° Wide	LED nominal lumen					8E*
		M 20°x50° Elliptical						9D*
								9F*
								9M*
								9N*
								9P*
								9Q*

11,8 W Warm Dimming COBLED		Lumen delivered up to 545 lm / Lumen maintenance: L70 B10=50,000 h						Finishes
Driver	Version	Optics	LED	K	CRI	lm	SDCM	Finishes
X Not included	FR0D	B 17° Narrow	DT	1800-3000	>90	35-1246	<4	8C
Constant current (mA)		H 38° Wide	LED nominal lumen					8D
								8F
								8E*
								9D*
								9F*
								9M*
								9N*
								9P*
								9Q*

Ø 45 mm | Accessories

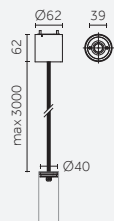

Description

Pendant accessories/
Accessorio pendant

*Special finishes/
Finiture speciali

Code
0.27416.00

Finishes

- 8C
- 8D
- 8F
- 8E*
- 9D*
- 9F*
- 9M*
- 9N*
- 9P*
- 9Q*

Ø 60 mm | Accessories

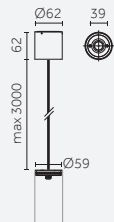

Description

Pendant accessories/
Accessorio pendant

*Special finishes/
Finiture speciali

Code
0.27424.00

Finishes

- 8C
- 8D
- 9D*
- 9F*
- 9M*
- 9N*
- 9P*
- 9Q*

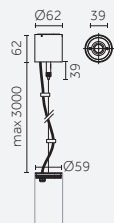

Description

Pendant accessories with steel cable/
Accessorio Pendant con cavo in acciaio

*Special finishes/
Finiture speciali

Code
0.27425.00

Finishes

- 8E*
- 8F

Internal accessories

EN Internal accessories are pre-mounted at the factory.
To specify Yori IP66 Surface/Pendant with an internal accessory:

- choose your product;
- choose one internal accessory;
- add the accessory code to the end of the product code.

IT Gli accessori interni sono integrati nel prodotto.
Per ordinare Yori IP66 Surface/Pendant con un accessorio interno:

- scegli il tuo prodotto;
- scegli un accessorio interno;
- aggiungi il codice accessorio alla fine del codice prodotto.



Examples:

Product code:
X.GR00A.HW8D
X.GR00A.HW8D

Accessory code:
.9A (Colored glass filter orange)
.S (Spread lens)

Product with accessory:
X.GR00A.HW8D.9A
X.GR00A.HW8D.S

68

EN To order two accessories select:

- one colored or selective filter (ie .9A);
- one honeycomb and accessories (ie .H);
- add the two codes to the end of the product code.

IT Per ordinare due accessori selezionare:

- un filtro colorato o selettivo (es. .9A);
- una griglia alveolare e accessori (es. .H);
- aggiungere i due codici alla fine del codice prodotto.





Example:	Product code: X.GR00A.HW8D <small>(Yori IP66 Surface/Pendant)</small>	Accessory 1: .9A <small>(Colored glass filter orange)</small>	Accessory 2: H <small>(Honeycomb)</small>	Product with 2 accessories: X.GR00A.HW8D.9AH
----------	---	---	---	---

Ø 45 mm | Ø 60 mm | Internal accessories



Colored and selective filters/
Filtri colorati e selettivi





Description	Code
 Colored glass filter red/ Filtro colorato rosso	<u>.4A</u>
 Colored glass filter green/ Filtro colorato verde	<u>.5A</u>
 Colored glass filter blue/ Filtro colorato blu	<u>.6A</u>

Description	Code
 Colored glass filter pink/ Filtro colorato rosa	<u>.7A</u>
 Colored glass filter yellow/ Filtro colorato giallo	<u>.8A</u>
 Colored glass filter orange/ Filtro colorato arancio	<u>.9A</u>



Description	Code
 Selective filter 2700-2000 K/ Filtro selettivo 2700-2000 K	<u>.20K</u>
 Selective filter 2700-2200 K/ Filtro selettivo 2700-2200 K	<u>.22K</u>



Description	Code
 Selective filter 2700-2500 K/ Filtro selettivo 2700-2500 K	<u>.25K</u>
 Selective filter 3000-3500 K/ Filtro selettivo 3000-3500 K	<u>.35K</u>

Lens and accessories/
Lenti e accessori



Description	Code
 Spread lens/ Lente diffondente	<u>.S</u>



Description	Code
 Honeycomb/ Griglia alveolare	<u>.H</u>
 Honeycomb + softener/ Griglia alveolare + filtro	<u>.L</u>





Description	Code
 Antiglare/ Antiglare	<u>.A</u>
Available only for Ø60mm/ Disponibile solo per Ø60mm	

Electrical devices



Ø45 mm | Electrical devices

Driver/ Alimentazioni

2 W POWER LED (2,7 W total product consumption)



Type	Code	Watt	Size (mm)	IP	Tech. specification / Input	Output	Connectable fixtures	Cable length max	Cable section
On/Off	0.30524.0000	12 W		20	220-240 Vac / 50/60 Hz	24 Vdc	Max: 4	See table: p. 73	See table: p. 73
On/Off	0.30525.0000	70 W		67	220-240 Vac / 50/60 Hz	24 Vdc	Max: 23	See table: p. 73	See table: p. 73
On/Off	0.30526.0000	150 W		67	220-240 Vac / 50/60 Hz	24 Vdc	Max: 50	See table: p. 73	See table: p. 73

3,2 W POWER LED (4,5 W total product consumption)



Type	Code	Watt	Size (mm)	IP	Tech. specification / Input	Output	Connectable fixtures	Cable length max	Cable section
On/Off	0.30524.0000	12 W		20	220-240 Vac / 50/60 Hz	24 Vdc	Max: 2	See table: p. 73	See table: p. 73
On/Off	0.30525.0000	70 W		67	220-240 Vac / 50/60 Hz	24 Vdc	Max: 14	See table: p. 73	See table: p. 73
On/Off	0.30526.0000	150 W		67	220-240 Vac / 50/60 Hz	24 Vdc	Max: 30	See table: p. 73	See table: p. 73

Dimmer/ Dimmer

2 W POWER LED (2,7 W total product consumption)

Type	Code	Watt	Size (mm)	IP	Tech. specification / Input	Output	Connectable fixtures	Cable length max	Cable section
DALI Dimm 1-10V Push	Y.30826.0000	150 W		20	24 Vdc	24 Vdc	Max: 50	See table: p. 73	See table: p. 73
DALI	D.30850.0000	150 W		67	24 Vdc	24 Vdc	Max: 50	See table: p. 73	See table: p. 73
DMX	DX.30851.0000	150 W		20	24 Vdc	24 Vdc	Max: 50	See table: p. 73	See table: p. 73



3,2 W POWER LED (4,5 W total product consumption)

Type	Code	Watt	Size (mm)	IP	Tech. specification / Input	Output	Connectable fixtures	Cable length max	Cable section
DALI Dimm 1-10V Push	Y.30826.0000	150 W		20	24 Vdc	24 Vdc	Max: 30	See table: p. 73	See table: p. 73
DALI	D.30850.0000	150 W		67	24 Vdc	24 Vdc	Max: 30	See table: p. 73	See table: p. 73
DMX	DX.30851.0000	150 W		20	24 Vdc	24 Vdc	Max: 30	See table: p. 73	See table: p. 73



Ø60 mm | Electrical devices

Driver/ Alimentazioni



4,5 W POWER LED (5,5 W total product consumption)

Type	Code	Watt	Size (mm)	IP	Tech. specification / Input	Output	Connectable fixtures	Cable length max	Cable section
On/Off	0.30524.0000	12 W		20	220-240 Vac / 50/60 Hz	24 Vdc	Max: 2	See table: p. 73	See table: p. 73
On/Off	0.30525.0000	70 W		67	220-240 Vac / 50/60 Hz	24 Vdc	Max: 11	See table: p. 73	See table: p. 73
On/Off	0.30526.0000	150 W		67	220-240 Vac / 50/60 Hz	24 Vdc	Max: 24	See table: p. 73	See table: p. 73

7 W POWER LED (8 W total product consumption)

Type	Code	Watt	Size (mm)	IP	Tech. specification / Input	Output	Connectable fixtures	Cable length max	Cable section
On/Off	0.30524.0000	12 W		20	220-240 Vac / 50/60 Hz	24 Vdc	Max: 1	See table: p. 73	See table: p. 73
On/Off	0.30525.0000	70 W		67	220-240 Vac / 50/60 Hz	24 Vdc	Max: 7	See table: p. 73	See table: p. 73
On/Off	0.30526.0000	150 W		67	220-240 Vac / 50/60 Hz	24 Vdc	Max: 16	See table: p. 73	See table: p. 73

12 W POWER LED (13 W total product consumption)



Type	Code	Watt	Size (mm)	IP	Tech. specification / Input	Output	Connectable fixtures	Cable length max	Cable section
On/Off	0.30524.0000	12 W		20	220-240 Vac / 50/60 Hz	24 Vdc	Max: 1	See table: p. 73	See table: p. 73
On/Off	0.30525.0000	70 W		67	220-240 Vac / 50/60 Hz	24 Vdc	Max: 5	See table: p. 73	See table: p. 73
On/Off	0.30526.0000	150 W		67	220-240 Vac / 50/60 Hz	24 Vdc	Max: 12	See table: p. 73	See table: p. 73

11,8 W Warm Dimming COB LED



Type	Code	Watt	Size (mm)	IP	Tech. specification / Input	Output	Connectable fixtures	Cable length max	Cable section
DALI	D.30527.0000	15 W		68	110-240V / 50/60 Hz	350 mA	Max: 1	See table: p. 73	See table: p. 73

Dimmer/ Dimmer



4,5 W POWER LED (5,5 W total product consumption)

Type	Code	Watt	Size (mm)	IP	Tech. specification / Input	Output	Connectable fixtures	Cable length max	Cable section
DALI Dimm 1-10V Push	Y.30826.0000	150 W		20	24 Vdc	24 Vdc	Max: 24	See table: p. 73	See table: p. 73
DALI	D.30850.0000	150 W		67	24 Vdc	24 Vdc	Max: 24	See table: p. 73	See table: p. 73
DMX	DX.30851.0000	150 W		20	24 Vdc	24 Vdc	Max: 24	See table: p. 73	See table: p. 73

7 W POWER LED (8 W total product consumption)

Type	Code	Watt	Size (mm)	IP	Tech. specification / Input	Output	Connectable fixtures	Cable length max	Cable section
DALI Dimm 1-10V Push	Y.30826.0000	150 W		20	24 Vdc	24 Vdc	Max: 16	See table: p. 73	See table: p. 73
DALI	D.30850.0000	150 W		67	24 Vdc	24 Vdc	Max: 16	See table: p. 73	See table: p. 73
DMX	DX.30851.0000	150 W		20	24 Vdc	24 Vdc	Max: 16	See table: p. 73	See table: p. 73

12 W POWER LED (13 W total product consumption)

Type	Code	Watt	Size (mm)	IP	Tech. specification / Input	Output	Connectable fixtures	Cable length max	Cable section
DALI Dimm 1-10V Push	Y.30826.0000	150 W		20	24 Vdc	24 Vdc	Max: 12	See table: p. 73	See table: p. 73
DALI	D.30850.0000	150 W		67	24 Vdc	24 Vdc	Max: 12	See table: p. 73	See table: p. 73
DMX	DX.30851.0000	150 W		20	24 Vdc	24 Vdc	Max: 12	See table: p. 73	See table: p. 73

Ø 45 mm | Ø 60 mm | Cables and connectors

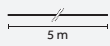

Description
Cable 0,5 mmq 5 m/
Cavo 0,5 mmq 5 m

Code
0.27450.0000

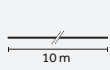

Description
Cable 0,5 mmq 10 m/
Cavo 0,5 mmq 10 m

Code
0.27451.0000

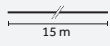

Description
Cable 0,5 mmq 15 m/
Cavo 0,5 mmq 15 m

Code
0.27452.0000



Description
Cable 0,5 mmq 20 m/
Cavo 0,5 mmq 20 m

Code
0.27453.0000

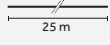

Description
Cable 0,5 mmq 25 m/
Cavo 0,5 mmq 25 m

Code
0.27454.0000

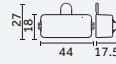

Description
Cable connector 0,5 mmq (2 way)/
Connettore per cavo 0,5 mmq (2 vie)

Code
0.27440.0000

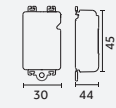

Description
Cable connector 0,5 mmq (3 way) T/
Connettore per cavo 0,5 mmq (3 vie) T

Code
0.27441.0000

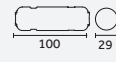

Description
Cable connector 2,5 mmq (2way)/
Connettore per cavo 2,5 mmq (2 vie)

Code
0.27430.0000

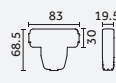

Description
Cable connector 2,5 mmq (3 way) T/
Connettore per cavo 2,5 mmq (3 vie) T

Code
0.27431.0000

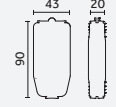

Description
Cable connector 2,5 mmq (3 way) Y/
Connettore per cavo 2,5 mmq (3 vie) Y

Code
0.27432.0000

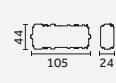

Description
Cable connector 2,5 mmq (4 way)/
Connettore per cavo 2,5 mmq (4 vie)

Code
0.27433.0000

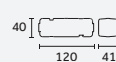

Description
Cable connector 4 mmq (2 way)/
Connettore per cavo 4 mmq (2 vie)

Code
0.27447.0000

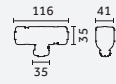

Description
Cable connector 4 mmq (3way) T/
Connettore per cavo 4 mmq (3 vie) T

Code
0.27448.0000

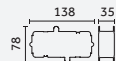

Description
Cable connector 4mmq (4 way)/
Connettore per cavo 4 mmq (4 vie)

Code
0.27449.0000

Wiring examples

Loop in loop out/
Loop in loop out/

Code Driver	Watt	Cable section	Cable length max
0.30524.0000	12 W	0,5 mmq	15 m
		1,5 mmq	35 m
		2,5 mmq	50 m
		4 mmq	100 m
0.30525.0000	70 W	0,5 mmq	5 m
		1,5 mmq	10 m
		2,5 mmq	20 m
		4 mmq	40 m
0.30526.0000	150 W	0,5 mmq	—
		1,5 mmq	5 m
		2,5 mmq	7,5 m
		4 mmq	17,5 m

Notes:

Recommended cable section in relation to the voltage drop/
Sezione del cavo consigliata in rapporto alla caduta di tensione

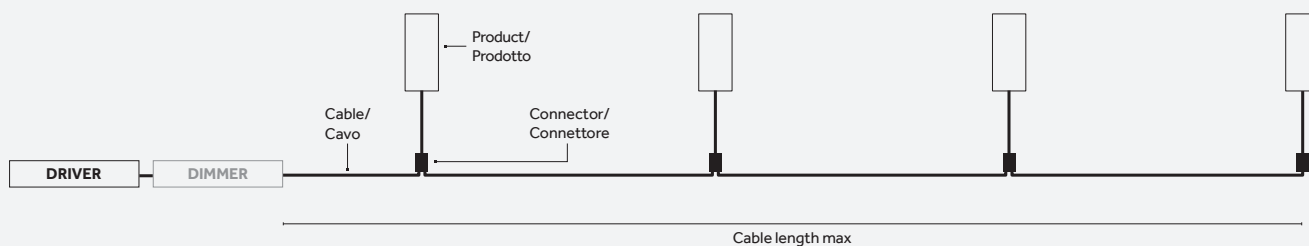

With central driver/
Con driver centrale/

Cable section	Total product consumption (Watt)						
	2,7 W	4,5 W	5,5 W	8 W	13 W	5,5 W + 5,5 W	8 W + 8 W
0,5 mmq	Max 60 m	Max 40 m	Max 30 m	Max 25 m	Max 15 m	Max 15 m	Max 10 m
1,5 mmq	Max 160 m	Max 110 m	Max 100 m	Max 70 m	Max 50 m	Max 50 m	Max 35 m
2,5 mmq	Max 500 m	Max 325 m	Max 300 m	Max 200 m	Max 125 m	Max 150 m	Max 100 m
4 mmq	Max 750 m	Max 550 m	Max 450 m	Max 325 m	Max 200 m	Max 225 m	Max 175 m

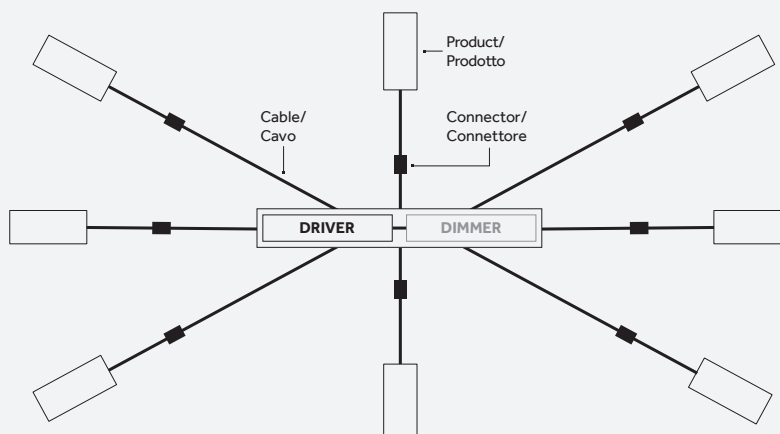

Yori IP66 Wall

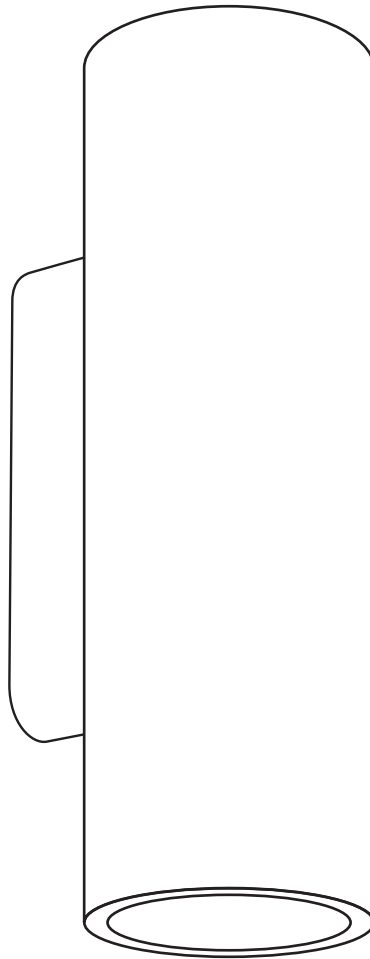

EN The up/down wall version of the Yori system, Yori Wall, is now available for the outdoors. Compact dimensions, nine color finishes and precision optics with smooth and efficient distributions, make Yori IP66 Wall an ideal solution for high-end architectural projects.

IT La versione up/down a muro del sistema Yori è ora disponibile anche per esterni. Le sue dimensioni compatte, le nove finiture di colore e le ottiche con distribuzione fluida ed efficiente rendono Yori IP66 Wall una soluzione ideale per progetti architettonici di fascia alta.

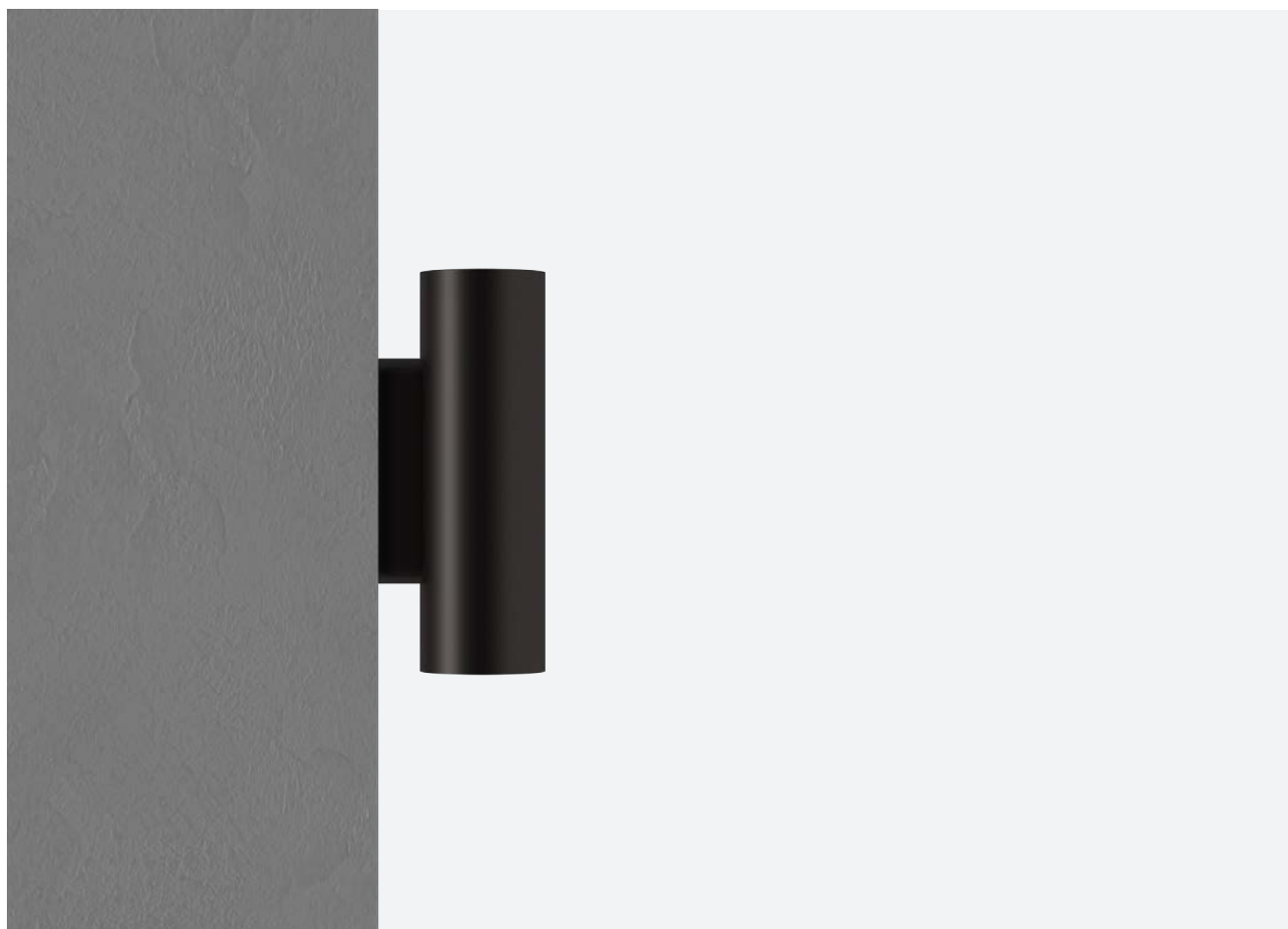

Versions/ Versioni			
Yori IP66 Wall	 <p data-bbox="456 591 496 613">Ø60</p>		
Finishes/ Finiture	 <p data-bbox="456 909 624 969">8C Raw anodized/ Anodizzato naturale</p>	 <p data-bbox="759 909 903 969">8D Black anodized/ Anodizzato nero</p>	 <p data-bbox="1078 909 1374 969">8F Antiqued bronze (solid brass)/ Bronzo anticato (ottone massiccio)</p>
Special finishes/ Finiture speciali	 <p data-bbox="456 1267 528 1328">9D Copper/ Rame</p>	 <p data-bbox="759 1267 959 1328">9F Champagne anodized/ Anodizzato champagne</p>	 <p data-bbox="1078 1267 1230 1328">9M Antiqued bronze/ Bronzo anticato</p>
<p data-bbox="177 1715 416 1798">If not specified, the product is made of aluminium/ Se non specificato, il prodotto è in alluminio</p>	 <p data-bbox="456 1626 560 1686">9N Olive green/ Verde oliva</p>	 <p data-bbox="759 1626 831 1686">9P Corten/ Corten</p>	 <p data-bbox="1078 1626 1166 1686">9Q Titanium/ Titanio</p>
IP / IK	66 / 07		
Control systems	On/Off, DALI, 1-10V, PUSH, DMX		
Insulation class			
Certifications	  		

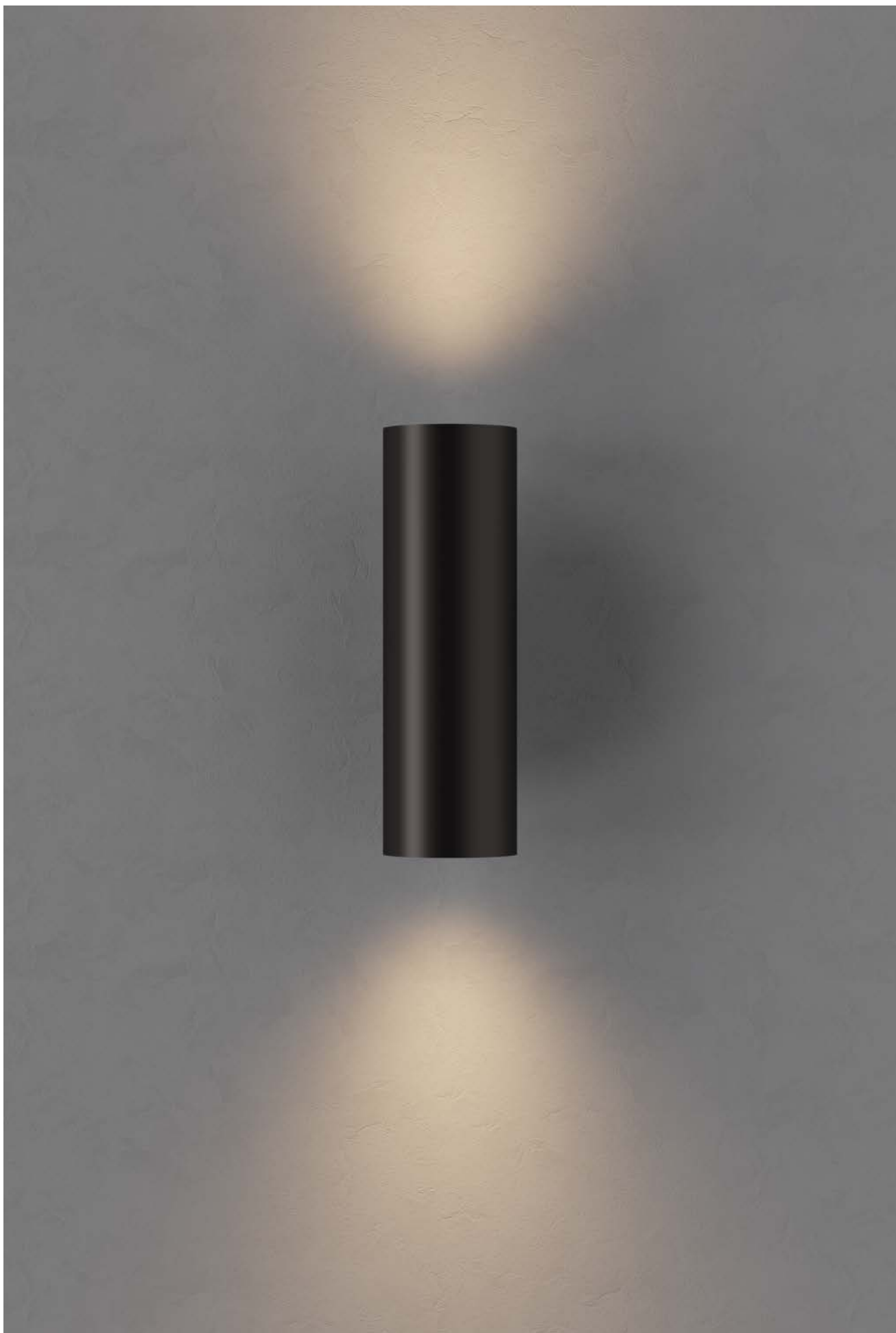

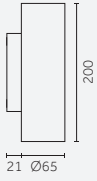
	<p>Ø 60 mm</p>
Yori IP66 Wall	 <p>p. 80</p>
△	<p>11°; 17°; 29°; 35°; 20°x50°</p>
Light source/ Sorgente luminosa	<p>POWER LED 4,5 W+4,5 W; 7 W+7 W 2x605 lm - 2x966 lm L80 B10=50,000h 2700 K; 3000 K; 4000 K SDCM <3 CRI >90</p> <p>Warm Dimming COB LED 6 W+6 W 2x(18 lm - 636 lm) L70 B10=50,000h 1800 K - 3000 K SDCM <4 CRI >90</p>

Ø 60 mm

Risk 1 | 0.74 | (8F) 1.44 | IP66 | IK07 | 850° | CE | EAC | UKA

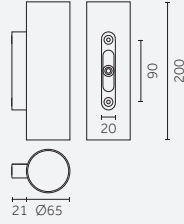

Code example:

X . DR01 A . HW 8C

Finishes: p. 89-91

Electrical devices: p. 84-86

Photometric data:

www.reggiani.net

Notes:

*Special finishes/
Finiture speciali

4,5+4,5 W POWERLED Lumen delivered up to 441+441 lm / Lumen maintenance: L80 B10=50,000 h

Driver	Version	Optics	LED	K	CRI	lm	SDCM	Finishes
X Not included	DR01 Dual emission	A 11° Very narrow	HW	2700	>90	605+605	<3	8C
Constant voltage (Vdc)		B 17° Narrow	HQ	3000	>90	647+647	<3	8D
		E 29° Medium	HN	4000	>90	697+697	<3	8F
		H 35° Wide	LED nominal lumen					9D*
		M 20°x50° Elliptical	LED nominal lumen					9F*
			LED nominal lumen					9M*
			LED nominal lumen					9N*
			LED nominal lumen					9P*
			LED nominal lumen					9Q*

7+7 W POWERLED Lumen delivered up to 611+611 lm / Lumen maintenance: L80 B10=50,000 h

Driver	Version	Optics	LED	K	CRI	lm	SDCM	Finishes
X Not included	DR02 Dual emission	A 11° Very narrow	HW	2700	>90	837+837	<3	8C
Constant voltage (Vdc)		B 17° Narrow	HQ	3000	>90	896+896	<3	8D
		E 29° Medium	HN	4000	>90	966+966	<3	8F
		H 35° Wide	LED nominal lumen					9D*
		M 20°x50° Elliptical	LED nominal lumen					9F*
			LED nominal lumen					9M*
			LED nominal lumen					9N*
			LED nominal lumen					9P*
			LED nominal lumen					9Q*

6+6 W Warm Dimming COB LED Lumen delivered up to 550+550 lm / Lumen maintenance: L70 B10=50,000 h

Driver	Version	Optics	LED	K	CRI	lm	SDCM	Finishes
X Not included	DR0D Dual emission	B 17° Narrow	DT	1800-3000	>90	2x(18-636)	<4	8C
Constant current (mA)		H 38° Wide	LED nominal lumen					8D
			LED nominal lumen					8F
			LED nominal lumen					9D*
			LED nominal lumen					9F*
			LED nominal lumen					9M*
			LED nominal lumen					9N*
			LED nominal lumen					9P*
			LED nominal lumen					9Q*

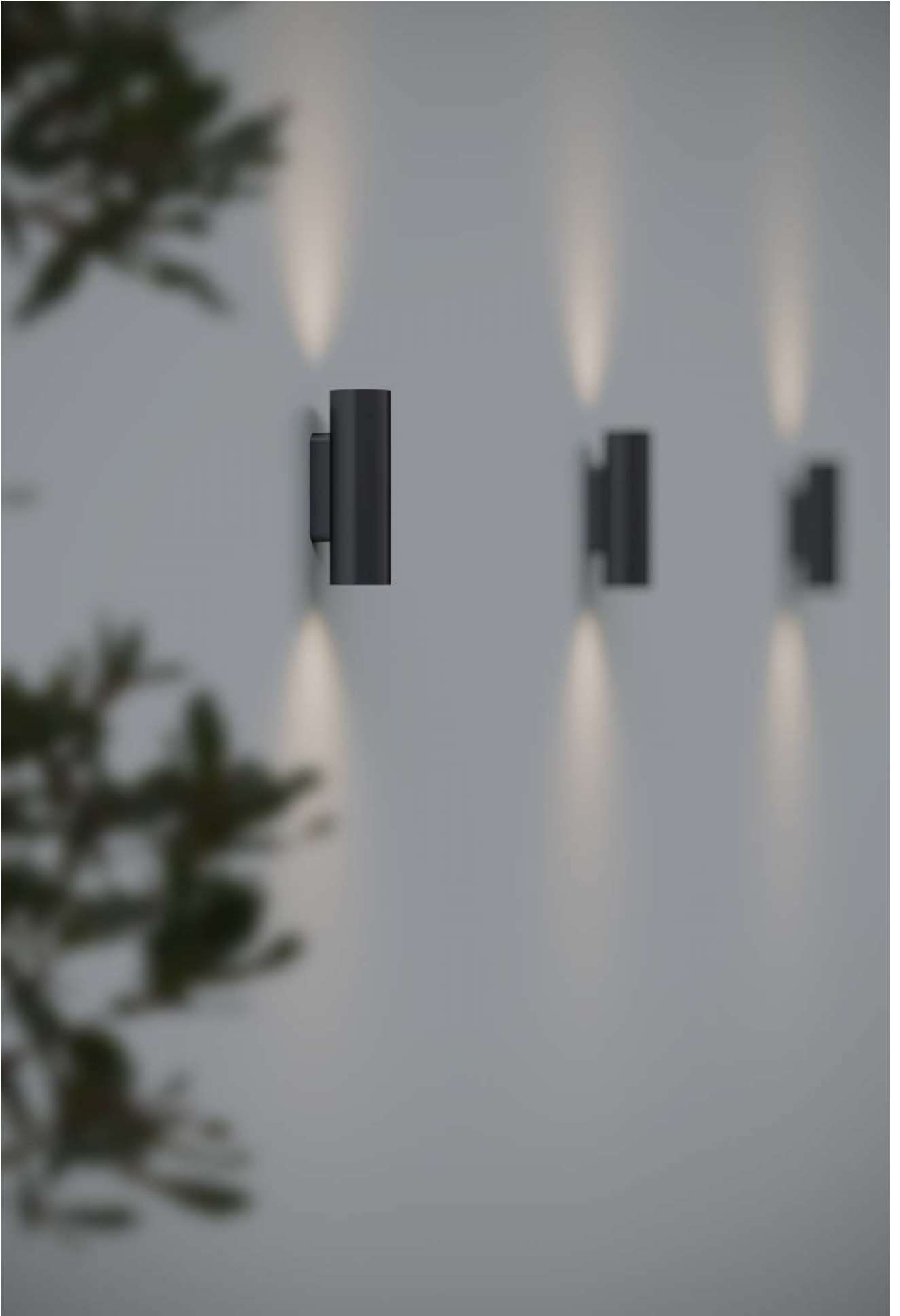

Yori IP66 Wall

Internal accessories

EN Internal accessories are pre-mounted at the factory.

To specify Yori IP66 Wall with an internal accessory:

- choose your product;
- choose one internal accessory;
- add the accessory code to the end of the product code.

IT Gli accessori interni sono integrati nel prodotto.

Per ordinare Yori IP66 Wall con un accessorio interno:

- scegli il tuo prodotto;
- scegli un accessorio interno;
- aggiungi il codice accessorio alla fine del codice prodotto.



Examples:

Product code:
X.DR01A.HW8D
X.DR01A.HW8D

Accessory code:
.9A (Colored glass filter orange)
.S (Spread lens)

Product with accessory:
X.DR01A.HW8D.9A
X.DR01A.HW8D.S

EN To order two accessories select:

- one colored or selective filter (ie .9A);
- one honeycomb and accessories (ie .H);
- add the two codes to the end of the product code.

IT Per ordinare due accessori selezionare:

- un filtro colorato o selettivo (es. .9A);
- una griglia alveolare e accessori (es. .H);
- aggiungere i due codici alla fine del codice prodotto.



Example:

Product code:
X.DR01A.HW8D
(Yori IP66 Wall)

Accessory 1:
.9A
(Colored glass filter orange)

Accessory 2:
H
(Honeycomb)

Product with 2 accessories:
X.DR01A.HW8D.9AH

Ø 60 mm | Internal accessories



Colored and selective filters/ Filtri colorati e selettivi



	Description	Code
	Colored glass filter red/ Filtro colorato rosso	<u>.4A</u>
	Colored glass filter green/ Filtro colorato verde	<u>.5A</u>
	Colored glass filter blue/ Filtro colorato blu	<u>.6A</u>

	Description	Code
	Colored glass filter pink/ Filtro colorato rosa	<u>.7A</u>
	Colored glass filter yellow / Filtro colorato giallo	<u>.8A</u>
	Colored glass filter orange/ Filtro colorato arancio	<u>.9A</u>



	Description	Code
	Selective filter 2700-2000 K/ Filtro selettivo 2700-2000 K	<u>.20K</u>
	Selective filter 2700-2200K/ Filtro selettivo 2700-2200K	<u>.22K</u>

	Description	Code
	Selective filter 2700-2500 K/ Filtro selettivo 2700-2500 K	<u>.25K</u>
	Selective filter 3000-3500 K/ Filtro selettivo 3000-3500 K	<u>.35K</u>

Lens and accessories/ Lenti e accessori



	Description	Code
	Spread lens/ Lente diffondente	<u>.S</u>



	Description	Code
	Honeycomb/ Griglia alveolare	<u>.H</u>

	Honeycomb + softener/ Griglia alveolare + filtro	<u>.L</u>
---	---	-----------





	Description	Code
	Antiglare/ Antiglare	<u>.A</u>

Electrical devices



Ø60 mm | Electrical devices

Driver/ Alimentazioni

4,5+4,5 W POWERLED (5,5 W + 5,5 W total product consumption)

Type	Code	Watt	Size (mm)	IP	Tech. specification / Input	Output	Connectable fixtures	Cable length max	Cable section
On/Off	0.30524.0000	12 W		20	220-240 Vac / 50/60 Hz	24 Vdc	Max: 1	See table: p. 86	See table: p. 86
On/Off	0.30525.0000	70 W		67	220-240 Vac / 50/60 Hz	24 Vdc	Max: 5	See table: p. 86	See table: p. 86
On/Off	0.30526.0000	150 W		67	220-240 Vac / 50/60 Hz	24 Vdc	Max: 12	See table: p. 86	See table: p. 86

7+7 W POWERLED (8 W + 8 W total product consumption)



Type	Code	Watt	Size (mm)	IP	Tech. specification / Input	Output	Connectable fixtures	Cable length max	Cable section
On/Off	0.30525.0000	70 W		67	220-240 Vac / 50/60 Hz	24 Vdc	Max: 4	See table: p. 86	See table: p. 86
On/Off	0.30526.0000	150 W		67	220-240 Vac / 50/60 Hz	24 Vdc	Max: 8	See table: p. 86	See table: p. 86

6+6 W Warm Dimming COB LED



Type	Code	Watt	Size (mm)	IP	Tech. specification / Input	mA	Connectable fixtures	Cable length max	Cable section
DALI	D.30527.0000	15 W		68	110-240V / 50/60 Hz	350 V	Max: 1	See table: p. 86	See table: p. 86

Dimmer/ Dimmer

4,5+4,5 W POWERLED (5,5 W + 5,5 W total product consumption)

Type	Code	Watt	Size (mm)	IP	Tech. specification / Input	Output	Connectable fixtures	Cable length max	Cable section
DALI Dimm 1-10V Push	Y.30826.0000	150 W		20	24 Vdc	24 Vdc	Max: 12	See table: p. 86	See table: p. 86
DALI	D.30850.0000	150 W		67	24 Vdc	24 Vdc	Max: 12	See table: p. 86	See table: p. 86
DMX	DX.30851.0000	150 W		20	24 Vdc	24 Vdc	Max: 12	See table: p. 86	See table: p. 86

7+7 W POWERLED (8 W + 8 W total product consumption)

Type	Code	Watt	Size (mm)	IP	Tech. specification / Input	Output	Connectable fixtures	Cable length max	Cable section
DALI Dimm 1-10V Push	Y.30826.0000	150 W		20	24 Vdc	24 Vdc	Max: 6	See table: p. 86	See table: p. 86
DALI	D.30850.0000	150 W		67	24 Vdc	24 Vdc	Max: 6	See table: p. 86	See table: p. 86
DMX	DX.30851.0000	150 W		20	24 Vdc	24 Vdc	Max: 6	See table: p. 86	See table: p. 86

Ø60 mm | Cables and connectors



Description
Cable 0,5 mmq 5 m/
Cavo 0,5 mmq 5 m

Code
0.27450.0000

Description
Cable 0,5 mmq 10 m/
Cavo 0,5 mmq 10 m

Code
0.27451.0000

Description
Cable 0,5 mmq 15 m/
Cavo 0,5 mmq 15 m

Code
0.27452.0000

Description
Cable 0,5 mmq 20 m/
Cavo 0,5 mmq 20 m

Code
0.27453.0000

Description
Cable 0,5 mmq 25 m/
Cavo 0,5 mmq 25 m

Code
0.27454.0000



Description
Cable connector 0,5 mmq (2 way)/
Connettore per cavo 0,5 mmq (2 vie)

Code
0.27440.0000



Description
Cable connector 0,5 mmq (3 way) T/
Connettore per cavo 0,5 mmq (3 vie) T

Code
0.27441.0000



Description
Cable connector 2,5 mmq (2 way)/
Connettore per cavo 2,5 mmq (2 vie)

Code
0.27430.0000



Description
Cable connector 2,5 mmq (3 way) T/
Connettore per cavo 2,5 mmq (3 vie) T

Code
0.27431.0000



Description
Cable connector 2,5 mmq (3 way) Y/
Connettore per cavo 2,5 mmq (3 vie) Y

Code
0.27432.0000



Description
Cable connector 2,5 mmq (4 way)/
Connettore per cavo 2,5 mmq (4 vie)

Code
0.27433.0000



Description
Cable connector 4 mmq (2 way)/
Connettore per cavo 4 mmq (2 vie)

Code
0.27447.0000



Description
Cable connector 4 mmq (3 way) T/
Connettore per cavo 4 mmq (3 vie) T

Code
0.27448.0000



Description
Cable connector 4 mmq (4 way)/
Connettore per cavo 4 mmq (4 vie)

Code
0.27449.0000

Wiring examples

Loop in loop out/
Loop in loop out/

Code Driver	Watt	Cable section	Cable length max
0.30524.0000	12 W	0,5 mmq	15 m
		1,5 mmq	35 m
		2,5 mmq	50 m
		4 mmq	100 m
0.30525.0000	70 W	0,5 mmq	5 m
		1,5 mmq	10 m
		2,5 mmq	20 m
		4 mmq	40 m
0.30526.0000	150 W	0,5 mmq	—
		1,5 mmq	5 m
		2,5 mmq	7,5 m
		4 mmq	17,5 m

Notes:

Recommended cable section in relation to the voltage drop/
Sezione del cavo consigliata in rapporto alla caduta di tensione

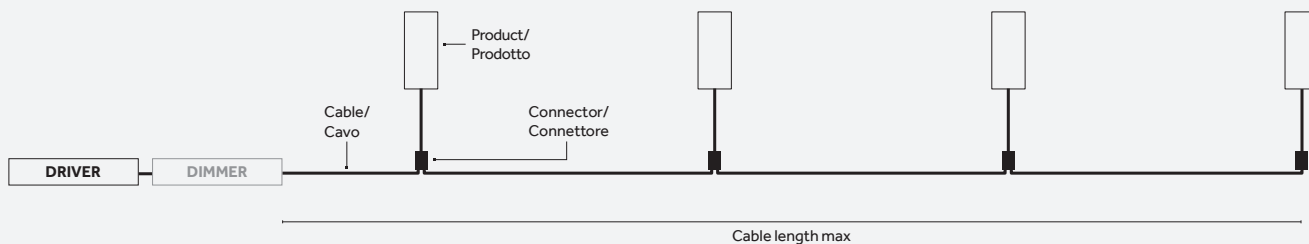

**With central driver/
Con driver centrale/**

Cable section	Total product consumption (Watt)						
	2,7 W	4,5 W	5,5 W	8 W	13 W	5,5 W + 5,5 W	8 W + 8 W
0,5 mmq	Max 60 m	Max 40 m	Max 30 m	Max 25 m	Max 15 m	Max 15 m	Max 10 m
1,5 mmq	Max 160 m	Max 110 m	Max 100 m	Max 70 m	Max 50 m	Max 50 m	Max 35 m
2,5 mmq	Max 500 m	Max 325 m	Max 300 m	Max 200 m	Max 125 m	Max 150 m	Max 100 m
4 mmq	Max 750 m	Max 550 m	Max 450 m	Max 325 m	Max 200 m	Max 225 m	Max 175 m

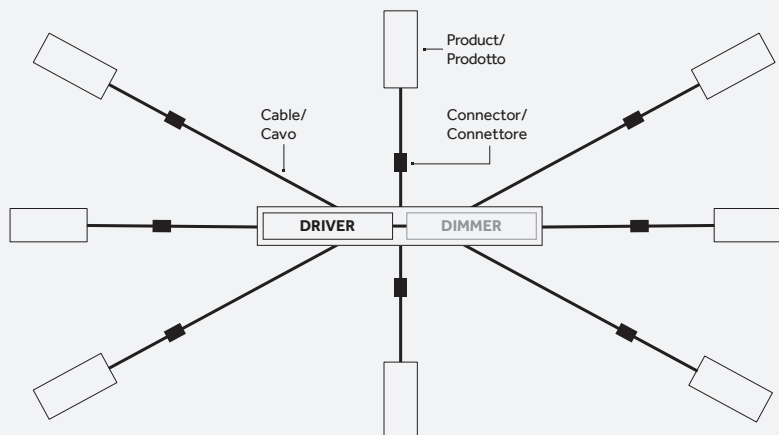

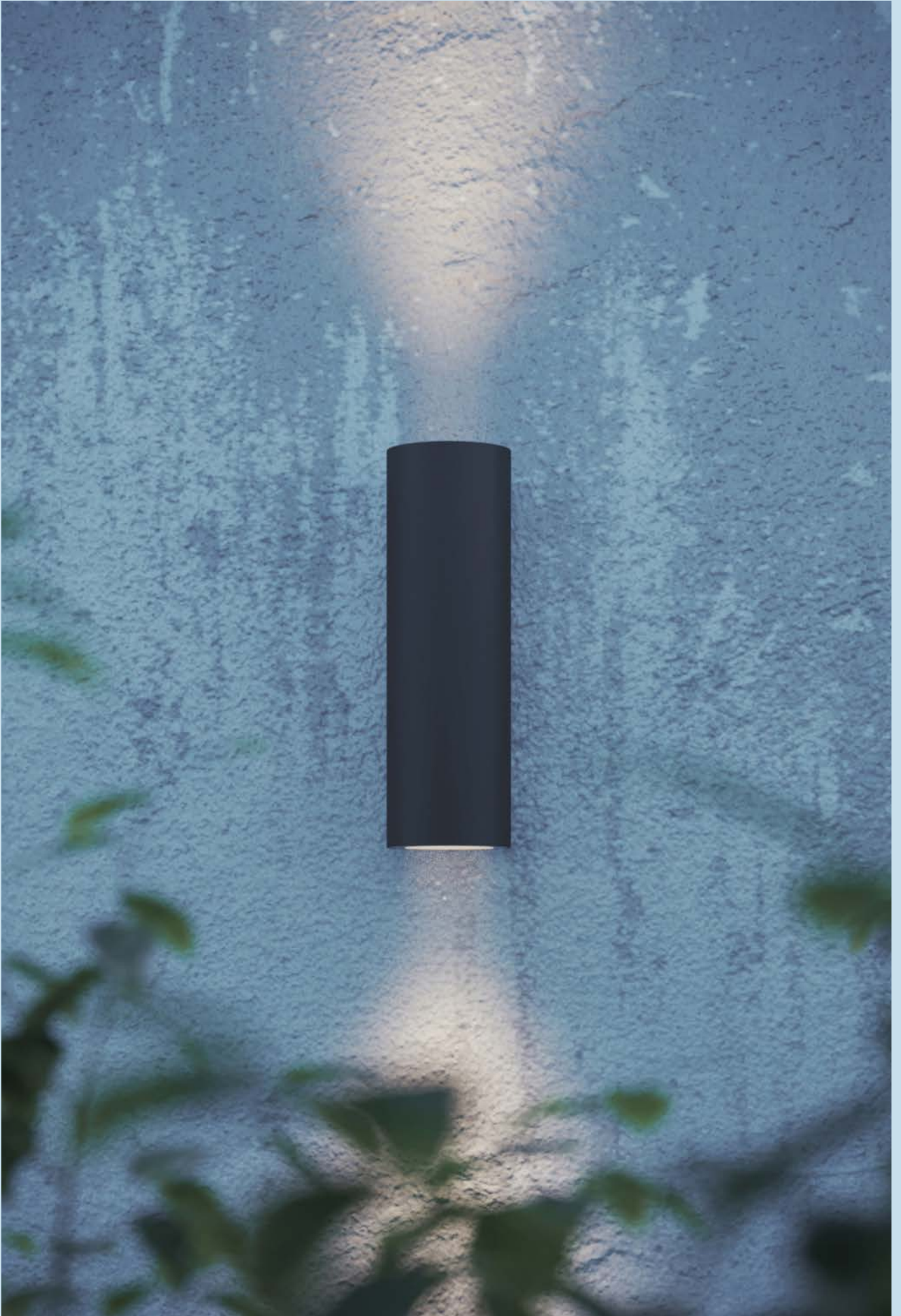

Yori IP66 Wall

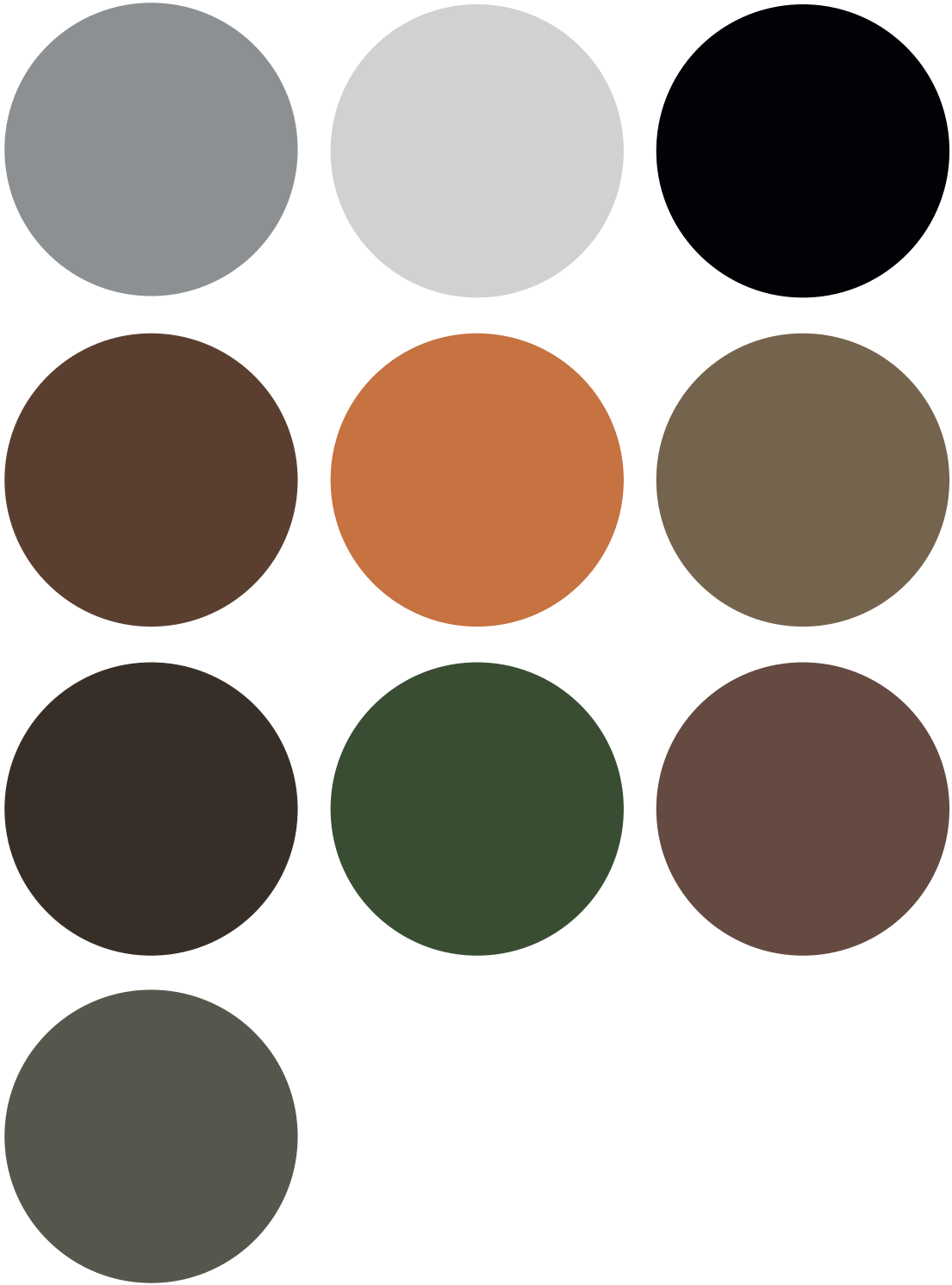

Finishes

^{EN} All products of the Yori IP66 range are machined from solid and are anodized or galvanized. The aluminium chosen for Yori IP66 is the 6026, a particular copper-free alloy with the ideal percentage of magnesium, guaranteeing maximum results in terms of corrosion resistance, surface hardness, wear/abrasion resistance and aesthetic durability: ideal for outdoor applications. In addition to the anodized aluminium versions, Yori IP66 is also available in solid brass and stainless steel (AISI 316).

^{IT} Tutti i prodotti della gamma Yori IP66 sono torniti dal pieno e anodizzati o galvanizzati. L'alluminio scelto per Yori IP66 è il 6026, una particolare lega priva di rame e con una percentuale di magnesio, che garantisce massimi risultati in termini di resistenza alla corrosione, durezza superficiale, resistenza all'usura/abrasione e durabilità estetica, quindi ideale per applicazioni all'esterno. Oltre alle versioni in alluminio anodizzato, Yori IP66 è disponibile anche in versione Ottone massiccio e Acciaio Inox (AISI 316).

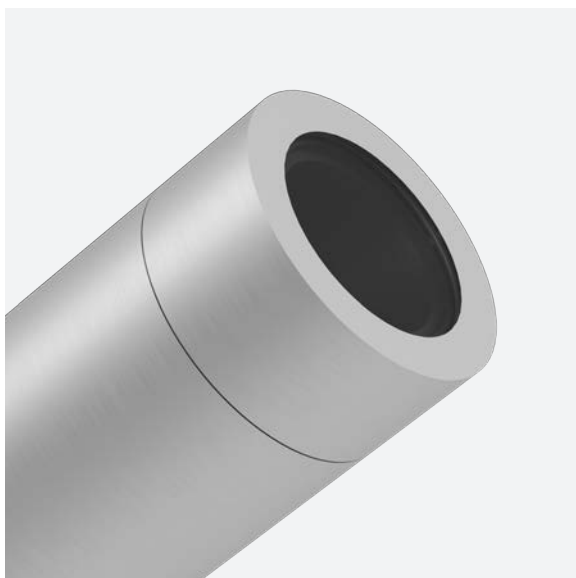

8C Raw anodized/
Anodizzato naturale



8D Black anodized/
Anodizzato nero

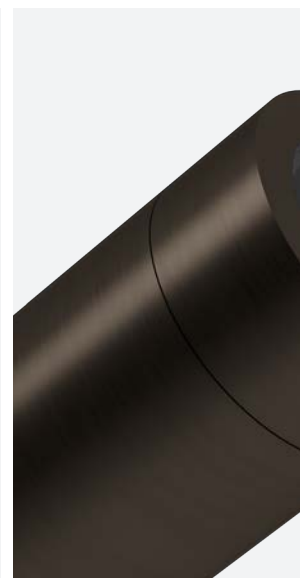

8F Antiqued bronze (solid brass)
Bronzo anticato (ottone massiccio)



9F* Champagne (anodized aluminium)/
Anodizzato champagne



9M* Antiqued bronze/
Bronzo anticato



9N* Olive green/
Verde oliva

Yori IP66 Ø45
Scale 1:1

^{EN} If not specified, the product is made of aluminium
^{IT} Se non specificato, il prodotto è in alluminio



s/
ssiccio)

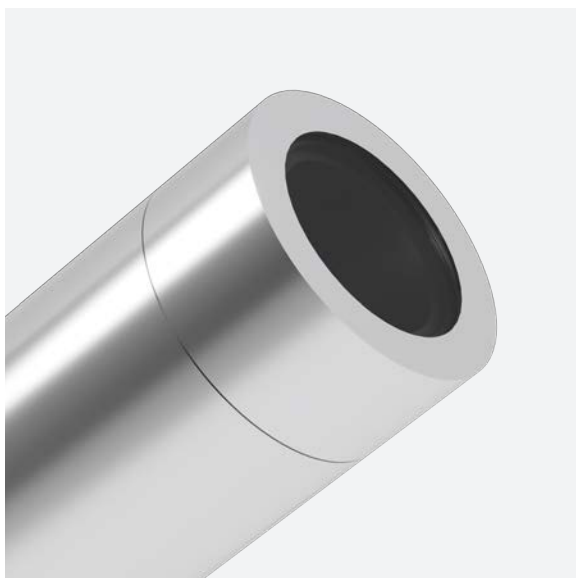

8E* Stainless steel (AISI 316)/
Acciaio inox (AISI 316)



9D* Copper/
Rame



9P* Corten/
Corten



9Q* Titanium/
Titanio

*Special finishes/
Finiture speciali

Reggiani

©

2022

Reggiani S.p.A. Illuminazione
All rights reserved

Art direction
Reggiani

Graphic design
Reggiani

Pictures
Reggiani
Lens visual

^{EN} Reggiani S.p.A. Illuminazione reserves the right to make technical, design and size changes at any time, without prior notice. Total or partial reproduction of this document is prohibited. Luminaire sizes are given in millimetres. All technical and design innovations are patented. Watts and lumens refer to the nominal values of the LED source; for photometric data and lumen output of the luminaires, visit www.reggiani.net

^{IT} Reggiani S.p.A. Illuminazione si riserva la facoltà di effettuare in qualsiasi momento senza preavviso, variazioni tecniche, formali e dimensionali. Sono vietate le riproduzioni anche parziali del presente documento. Le dimensioni degli apparecchi sono espresse in millimetri. Tutte le innovazioni tecniche e formali sono coperte da brevetto. Watt e lumen fanno riferimento ai valori nominali della sorgente LED, per i dati fotometrici e il lumen output degli apparecchi visitare www.reggiani.net

HEADQUARTERS
Reggiani S.p.A. Illuminazione

Viale Monza 16
20845 Sovico (MB), Italy
T. (+39) 039 20711
contact@reggiani.net



www.reggiani.net

#theilluminationcollective

Reggiani