

VECTOR

SPORTS LIGHTING

Flawless ultra precise light distribution with revolutionary lens sealing on module technology



Modularity
Light output ratio (LOR \geq 0.95)
Wide application range
Wide range of optics

BUCK
www.buck.lighting

BUCK GmbH
Hietzinger Kai 67-69, 1130 Vienna
Office address:
Fleischmarkt 1 | 6th floor |
1010 Vienna | Austria
office@bucklicht.at
www.bucklicht.at

Copyright © 2023 BUCK, edition: 2



VECTOR is top quality, highly energy efficient LED luminaire, suitable for extreme ambient conditions. Wide range of light output and light distributions make it suitable for different types of lighting in public spaces. Lighting management leads to smart energy consumption.

40 different optics

Efficiency
95%



Ambient temperatures
30 - 40°C

ENERGY EFFICIENCY

By choosing appropriate light distribution and distances between luminaires, depending on heights, there are significant reductions in required installed power (compared to standard light sources).

Considering longevity of all components (>100,000h), the need for maintenance is reduced, leading to additional savings.



OPEN DESIGN

Sports floodlights feature an open housing approach to design enabling safe operation and long-lasting lighting equipment. Increased resistance to extreme weather conditions (heat, rain, salty atmosphere) makes our LED sports lighting a good choice for any sports field. Reliable and easy-to-use solution for various outdoor and sports spaces.

Flawless ultra-precise light distribution with revolutionary lens sealing on module technology

THERMAL MANAGEMENT

The combination of robust heat sink and IP protection of LED modules enables excellent thermal management and safe operation over life time. Open design of luminaire provides natural air flow and guarantees operating at high ambient temperatures.

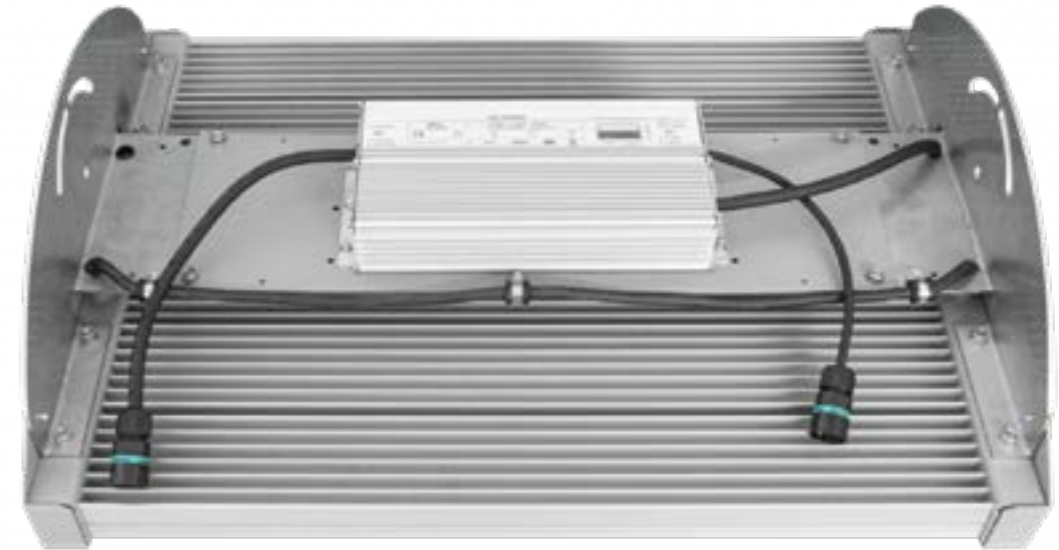
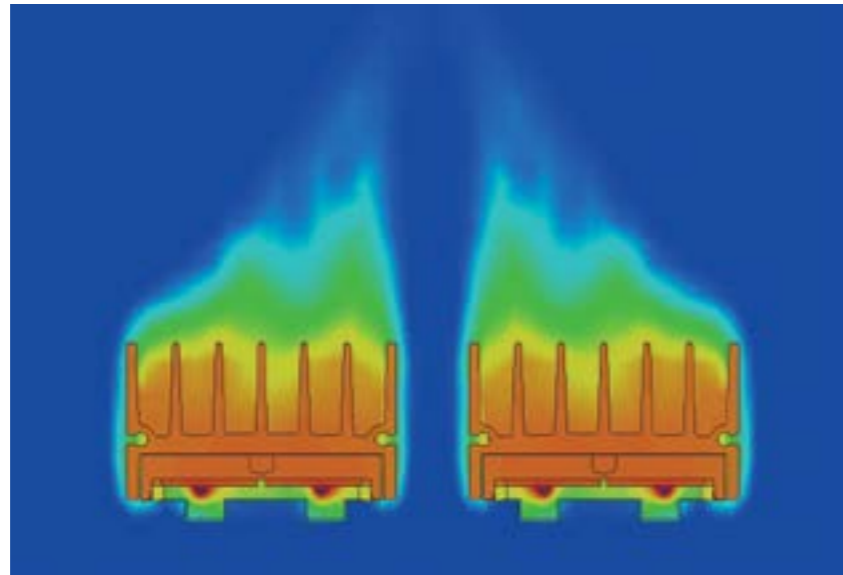

MODULARITY

One luminaire type VECTOR features 8 / 12 / 24 prefabricated modules containing LED-s, optics and cooling part. This approach enables the whole area to be illuminated in the desired way, with only one luminaire model. We have carefully developed and selected the range of products, with appropriate optical components and mounting methods, to meet the general and specific requirements of different sports.

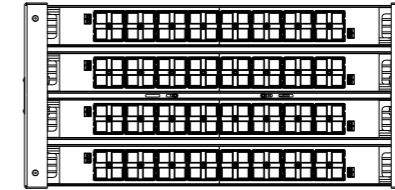

VECTOR 8

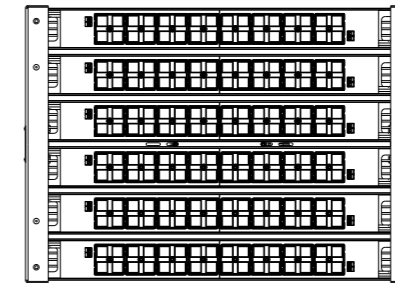

VECTOR 12

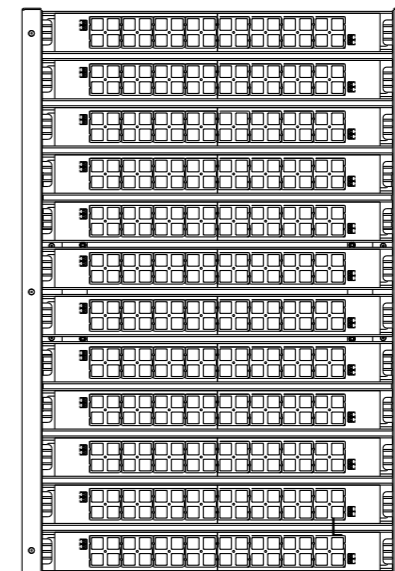

VECTOR 24

	DIMENSIONS A/B/H	LED LUMEN (4000K/CRI 70) MIN/MAX	TOTAL POWER (W) MIN/MAX	NUMBER OF LEDS	WEIGHT
VECTOR 8	300/630/185	41907/56825	279/400	128	12
VECTOR 12	450/630/185	62861/85238	418/600	192	26
VECTOR 24	902/621/206	125721/197900	830/1430	384	38

OPTICS

PMMA lenses of high light transmission (95%). A vast range of different powers and lenses cater for wide application in all types of indoor or outdoor illumination.

The distribution of light is defined by lenses made of optical grade PMMA with high UV and temperature conditions. These lenses allow better targeting of light rays so that the light scattering to adjacent buildings and light pollution is minimized. Numerous light distribution are available due to use of standardized lenses.

The lighting requirements that may occur in indoor and outdoor sports areas can meet spaces such as sports fields and swimming pools by choosing an appropriate light distribution.

Revolutionary improvement is achieved thanks to innovative technology from BUCK R&D center that combines special sealing of lenses on top of the LED module which allows ultra-precise light beam with minimum dissipation.



41907 lm
to
197900 lm

PMMA LENSES
95% LOR



OPTIC TYPES

SPORTS STANDARD OPTIC

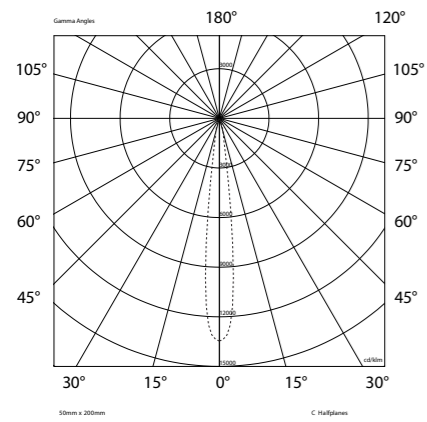

RS

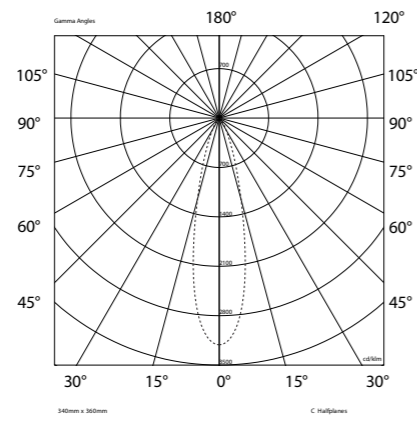

M

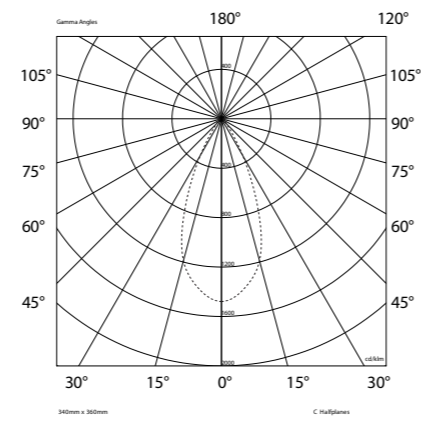

RW

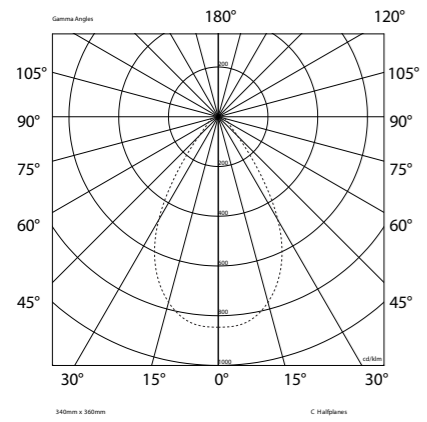

WW

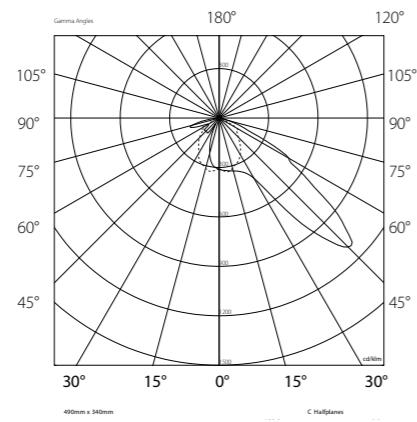

FN

OPTIC TYPES ON REQUEST

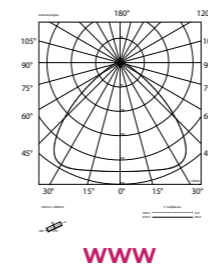

WWW

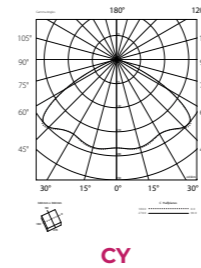

CY

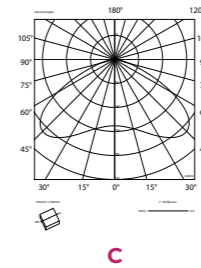

C

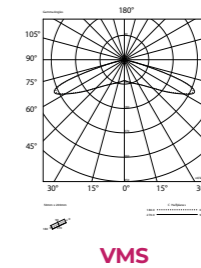

VMS

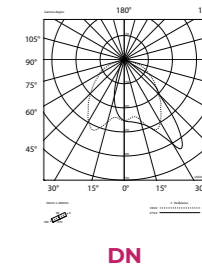

DN

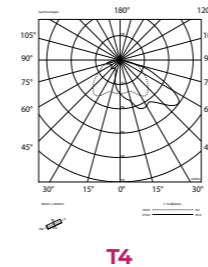

T4

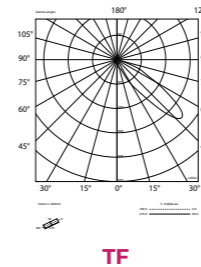

TF

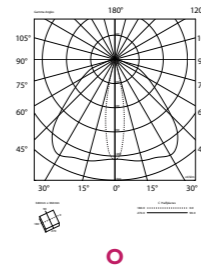

O

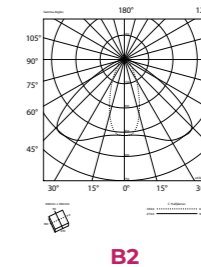

B2

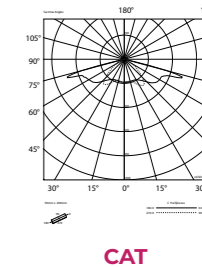

CAT

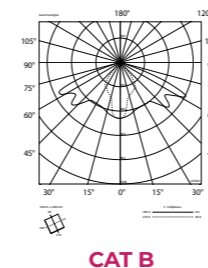

CAT B

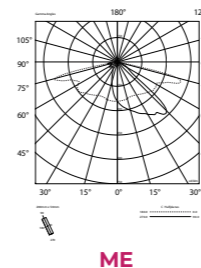

ME

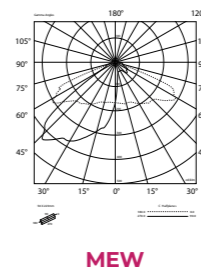

MEW

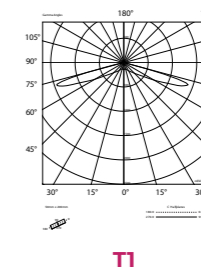

T1

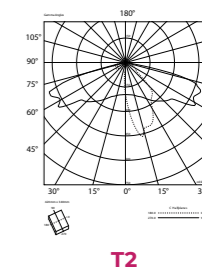

T2

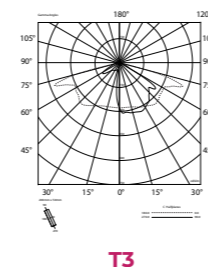

T3

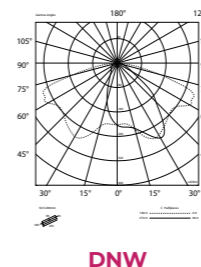

DNW

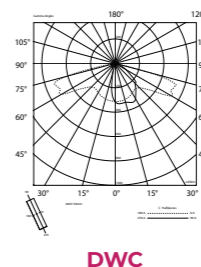

DWC

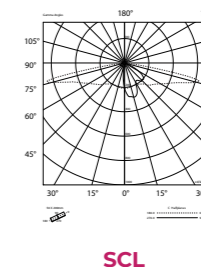

SCL

APPLICATION / USE

SWIMMING POOL

HORIZONTAL CALCULATION SURFACE

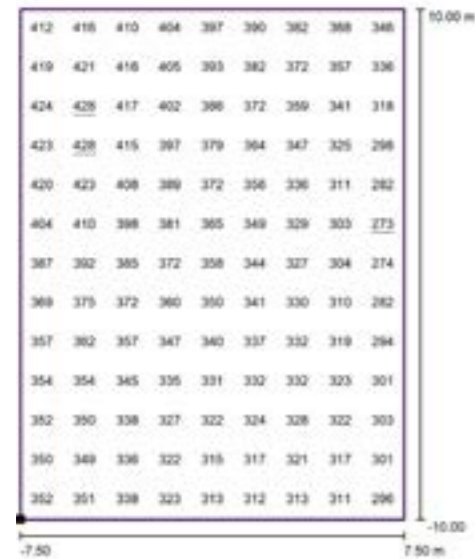

Values in Lux, Scale 1 : 161

Position of surface in external scene:
Marked point: (17.000 m, 15.934 m,
0.000 m)



Grid: 9 x 13 Points

E_{av} [lx]	E_{min} [lx]	E_{max} [lx]	$u0$	E_{min} / E_{max}
354	273	428	0.77	0.64

APPLICATION

When illuminating outdoor pools, the floodlight VECTOR 8 with narrow beam symmetric optics (M) provides the required illumination level within the pool limits (without light dissipation). The mounting height on 18m, terrain dimensions 20x 15m with total of 18 luminaires on four masts. The obtained calculation result is in accordance with class II of outdoor water polo pool EN12193 ($E_{av} > 300lx$, $u0 > 0.7$).

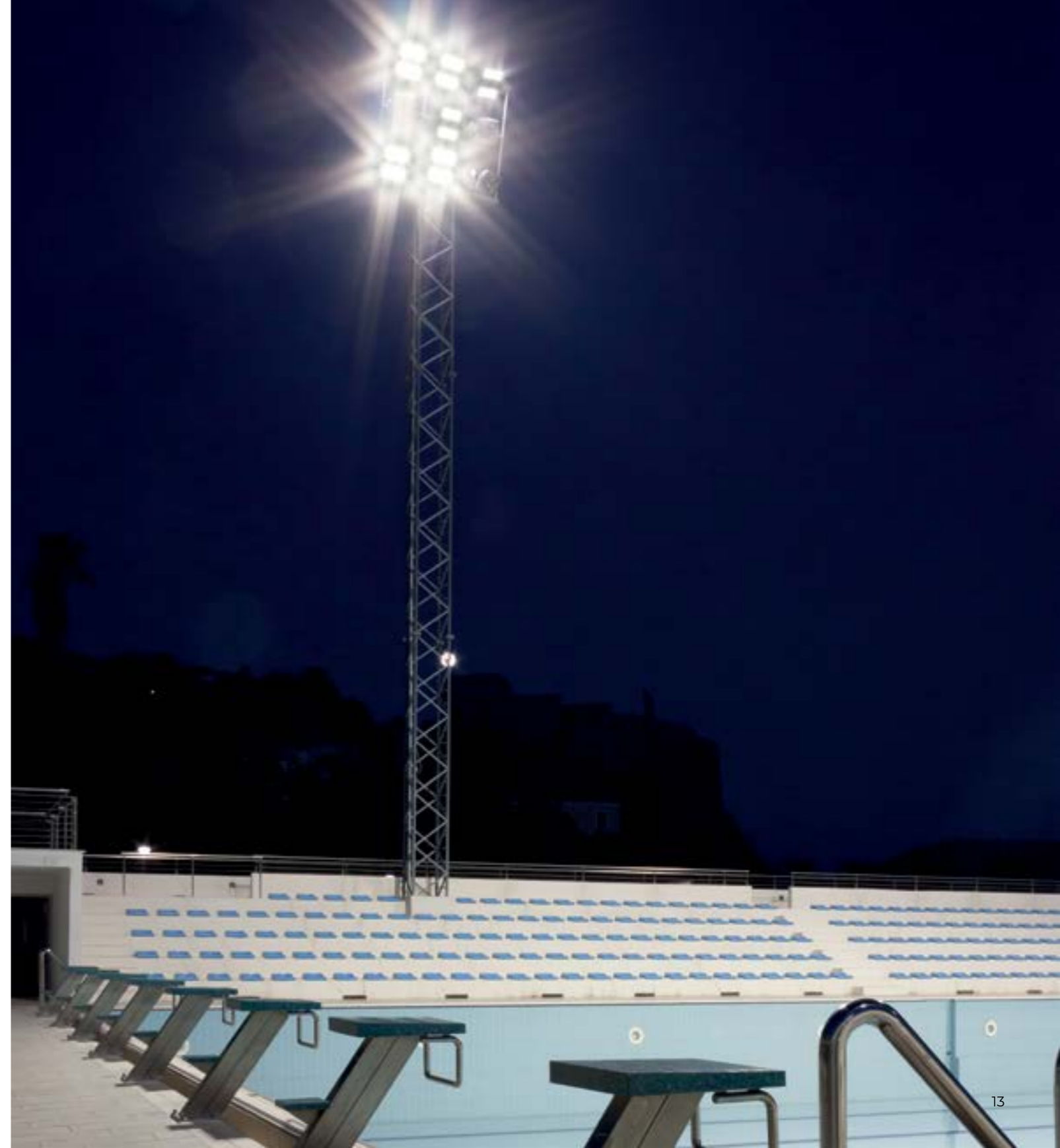
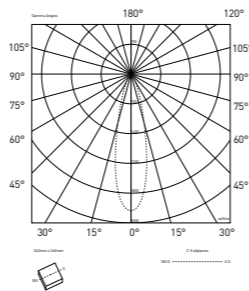

APPLICATION / USE

FOOTBALL STADIUM

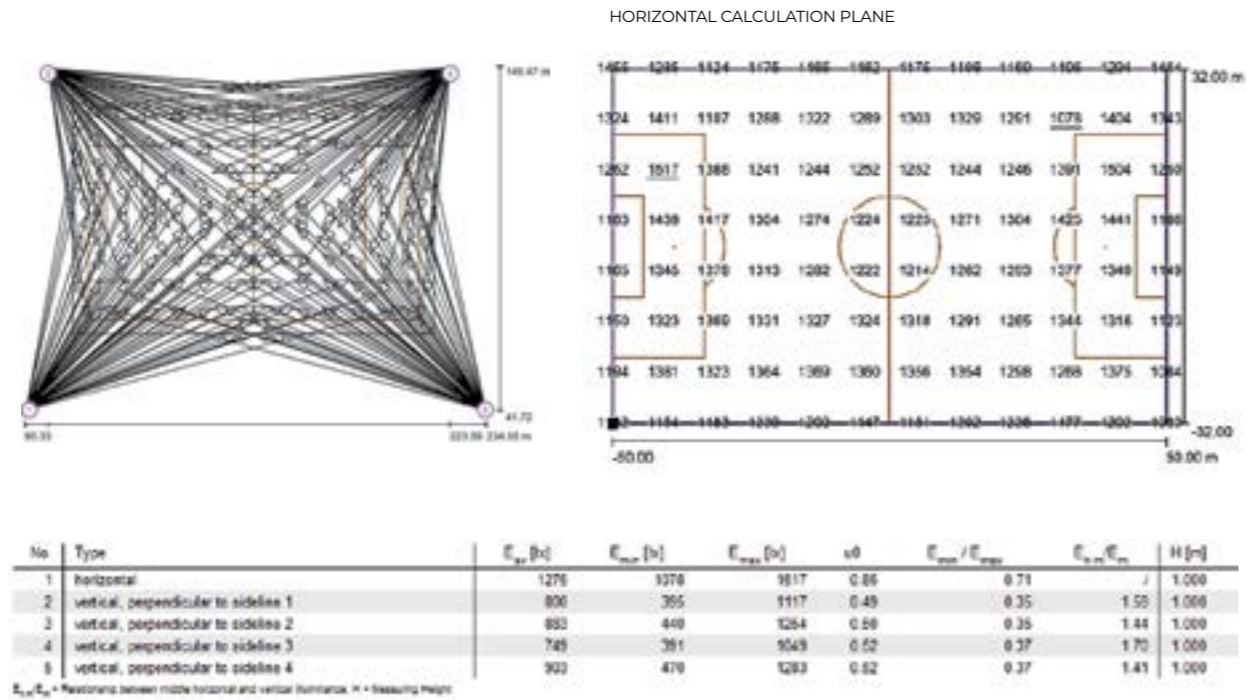

APPLICATION

When illuminating the football stadium, the floodlight VECTOR 12 with narrow beam symmetric optics (RS) provides the required illumination level within the terrain limits (without light dissipation). The mounting height ranges from 35m to 53m, terrain dimensions 100x 64m with total of 248 luminaires on four masts. The obtained calculation results are in accordance with UEFA 2016 standard for illumination, class C (horizontal calculation field $E_{av}>1200lx$, $u0>0.6$, $E_{min}/E_{max}>0.4$, vertical calculation field $0,90,180,270^\circ$ - $E_{av}>750lx$, $u0>0.45$, $E_{min}/E_{max}>0.35$).

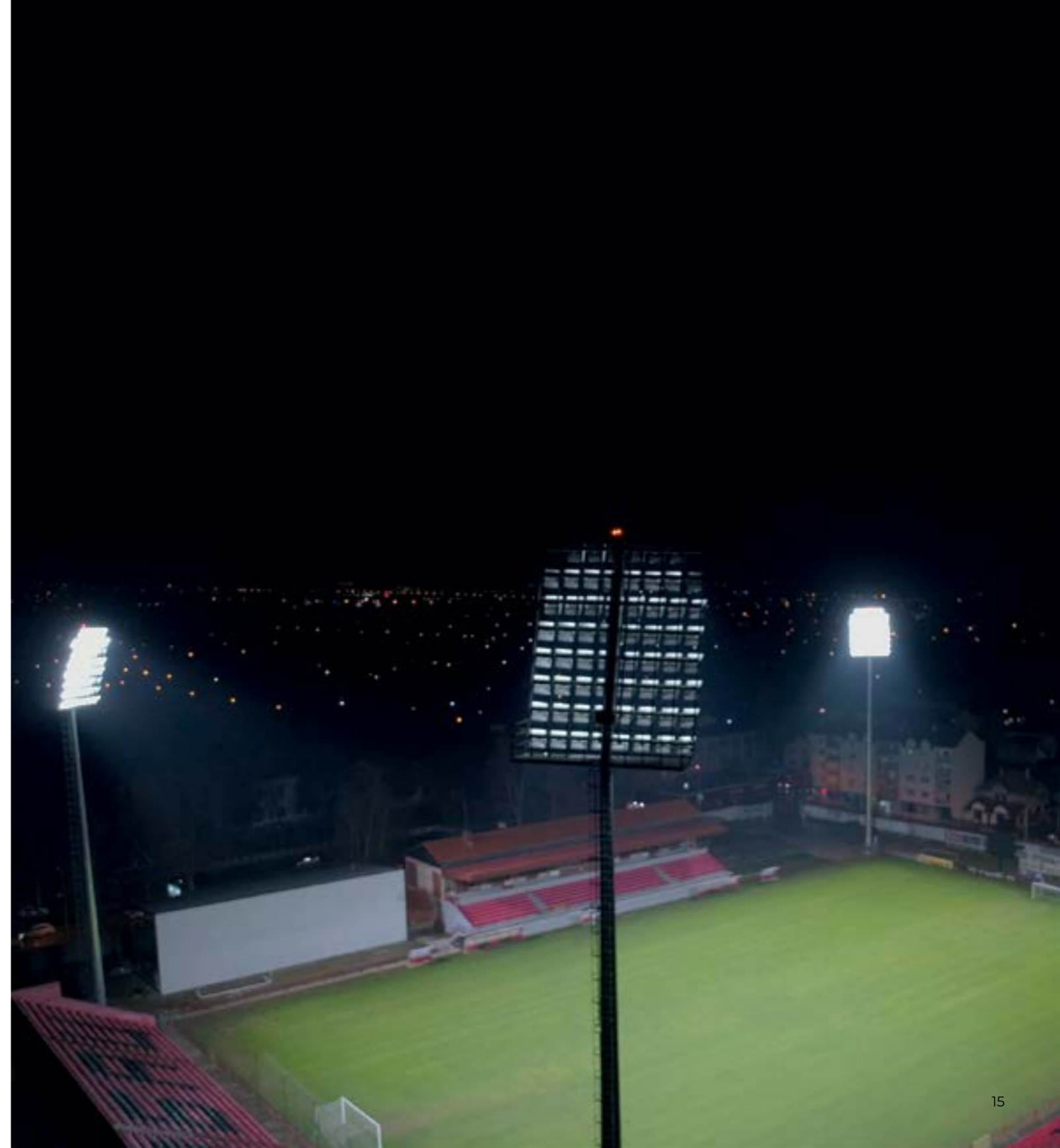
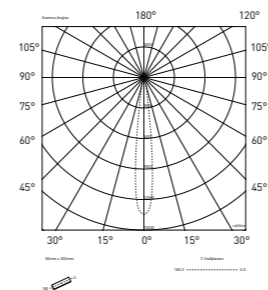

APPLICATION / USE

FOOTBALL STADIUM



TECHNICAL DATA

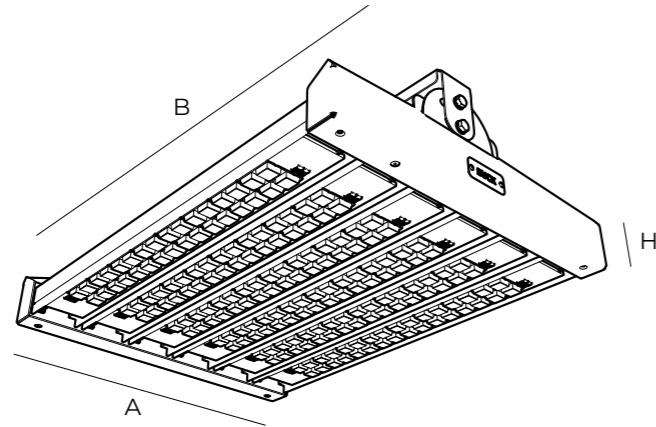

Ingress protection rating	IP66
Finish	black, gray
Ta	≤40°C
Led source	2x8LED modul
LED service life	>100 000h(L90B10)
Lens LOR	95%
Luminaire luminous flux	41907- 197900lm
Total power	279- 1430W
Luminaire efficiency	138-150lm/W
Light color temperature	4000K opt 2700K 3000K 5700K 6500K
CRI	70 opt 80, 90
Power supply	220-240VAC (198=264V) 50 60Hz
Constant current range	700-1200mA
Control gear	ECG, DIMM 1-10 opt DALI, DMX

The housing is made of aluminum sheet and a cooler of extruded profile made of an aluminum alloy, with improved corrosion resistance, combined. Other mechanical parts are made of stainless steel. Finishing is a conversion coating that provides better adhesion of the final layer.

Open concept housing design and massive cooler provide a high degree of application in environments with temperatures up to 40 °C, the possibility of maximum current discharge of the LED module as well as reduced wind resistance. Greater corrosion resistance and successful application in aggressive environments with increased salinity.

Light intensity adjustment, thermal protection, 6kV opt 10kV.

Different types of mounting are possible, on a reflector bracket with an adjustable joint on one or two axes.

STANDARD EQUIPMENT

- Programmable
- AOC - Adjustable Output Current
- Overvoltage protection 6 kW
- Electronic short-circuit protection
- Overload protection
- Thermal protection
- 1-10V analog dimming

ADDITIONAL EQUIPMENT

- DALI
- DMX
- Central management
- Overvoltage protection - 10kV
- Thermal protection of drivers and modules

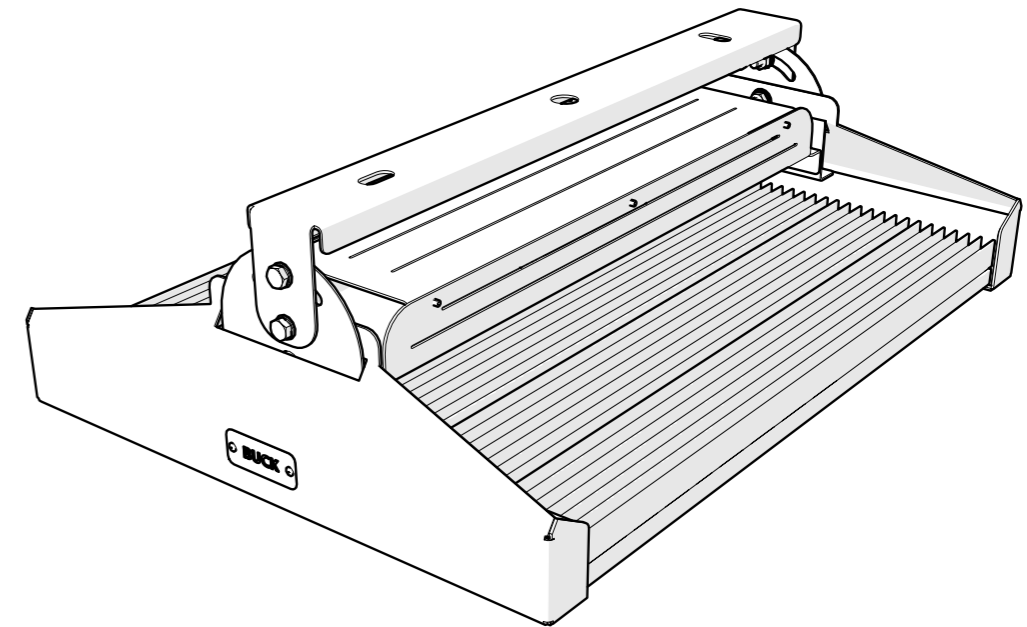

CENTRAL MANAGEMENT SYSTEM

